

SHOWA

Genuine Parts



2023

by GENUINE PARTS EUROPE

SHOWA

by GENUINE PARTS EUROPE



INFORMATION

Official catalog for SHOWA GENUINE PARTS.

All the information you need about Showa equipped MX bikes.

HONDA CRF, KAWASAKI KXF and SUZUKI RMZ.

Spare parts & oil is listed.

SHOWA GENUINE parts warranty the perfect fitting, quality and performance.

To make a correct use it's necessary to identify the model and year of the bike firstly, search procedure:

YEAR / MODEL / CAPACITY

Example:
2011 / KXF / 250

All the pictures are orientative, just the ref are concordant with the correct parts.

If you have any question please e-mail us!
contact@showabygenuinepartseurope.com



SHOWA

by GENUINE PARTS EUROPE



INFORMATION

SHOWA

G e n u i n e P a r t s

ATTENTION!

Genuine Showa parts only with Genuine packaging!





INFORMATION	PG
Application list	4
FRONT FORK	5
Ø 47 mm	6
Ø 47 mm SFF	13
Ø 48 mm	21
Ø 48 mm SFF	29
Ø 49 mm SFF AIR	38
Ø 49 mm	51
Seal & bush application list	58
REAR SHOCK	59
OIL	68
GREASE	69
SERVICE KITS	70



SHOWA EQUIPPED LIST

HONDA	FRONT FORK				SHOCK		
	Ø 47	Ø 48	SFF Ø 48	SFF AIR Ø 49	Ø 49	Ø 16	Ø 18
CRF 250 09	○					○	
CRF 250 10 - 12		○				○	
CRF 250 13 - 14			○			○	
CRF 250 15 - 17				○		○	
CRF 250 18 - 23					○	○	
CRF 450 17 - 23					○	○	
CRF X 450 17 - 23					○	○	

KAWASAKI	FRONT FORK				SHOCK		
	Ø 47	Ø 48	Ø 48 SFF	Ø 49 SFF AIR	Ø 49	Ø 16	Ø 18
KXF 250 09 - 10	○					○	
KXF 250 11 - 12	○					○	
KXF 250 13 - 19			○			○	
KXF 450 15 - 18				○		○	
KXF 450 19 - 23					○	○	

SUZUKI	FRONT FORK				SHOCK		
	Ø 47	Ø 48	SFF Ø 48	SFF AIR Ø 49	Ø 49	Ø 16	Ø 18
RMZ 250 09 - 12	○						○
RMZ 250 13 - 15			○				○
RMZ 450 09 - 12	○						○
RMZ 450 13 - 14			○				○
RMZ 450 15 - 17				○			○
RMZ 450 18 - 23					○	○	

SERVICE KITS FRONT FORK

APPLICATION CHART



FRONT FORK SERVICE KIT WITHOUT OIL:
2 OIL SEAL / 2 DUST SEAL / 2 GUIDE BUSH / 2 SLIDE BUSH

REFERENCE	NAME PART	QTY	HONDA										
			Ø 37	Ø 37	Ø 47	Ø 47	Ø 48	Ø 49	Ø 47	Ø 49	Ø 49	Ø 49	
			02-07 CR 85	07-20 CRF 150	97-07 CR 250	04-09 CRF 250	10-14 CRF 250	15-23 CRF 250	02-08 CRF 450R	17-23 CRF 450R	17-23 CRF 450WE	17-23 CRF 450X	
RMAN04701WO	SERVICE KIT FF NO OIL	1			○	○				○			
FMAN04801WO	SERVICE KIT FF NO OIL	1					○						
FMAN04802WO	SERVICE KIT FF NO OIL	1											
FMAN04901WO	SERVICE KIT FF NO OIL	1											
FMAN04902WO	SERVICE KIT FF NO OIL	1											
FMAN04903WO	SERVICE KIT FF NO OIL	1							○		○	○	○
FMAN08501WO	SERVICE KIT FF NO OIL	1	○	○									

REFERENCE	NAME PART	QTY	KAWASAKI		
			Ø 47	Ø 48	Ø 49
			06-12 KXF 250	13-19 KXF 250	15-23 KXF 450
RMAN04701WO	SERVICE KIT FF NO OIL	1	○		
FMAN04801WO	SERVICE KIT FF NO OIL	1			
FMAN04802WO	SERVICE KIT FF NO OIL	1		○	
FMAN04901WO	SERVICE KIT FF NO OIL	1			○
FMAN04902WO	SERVICE KIT FF NO OIL	1			
FMAN04903WO	SERVICE KIT FF NO OIL	1			
FMAN08501WO	SERVICE KIT FF NO OIL	1			

REFERENCE	NAME PART	QTY	SUZUKI									
			Ø 37	Ø 47	Ø 47	Ø 47	Ø 48	Ø 47	Ø 48	Ø 49	Ø 49	
			02-20 RM 85	01-08 RM 125	04-09 RM 250	07-12 RMZ 250	13-15 RMZ 250	04-12 RMZ 450	13-14 RMZ 450	15-17 RMZ 450	18-23 RMZ 450	
RMAN04701WO	SERVICE KIT FF NO OIL	1		○	○	○			○			
FMAN04801WO	SERVICE KIT FF NO OIL	1										
FMAN04802WO	SERVICE KIT FF NO OIL	1					○		○			
FMAN04901WO	SERVICE KIT FF NO OIL	1										
FMAN04902WO	SERVICE KIT FF NO OIL	1								○		
FMAN04903WO	SERVICE KIT FF NO OIL	1										○
FMAN08501WO	SERVICE KIT FF NO OIL	1	○									

SERVICE KITS REAR SHOCK

APPLICATION CHART



REAR SHOCK SERVICE KIT:
PISTON RING / PISTON O RING / DUST SEAL / OIL SEAL / GUIDE BUSH / SEAL HEAD - ORING / STOPPER RUBBER / BLADDER

REFERENCE	NAME PART	QTY	HONDA								KAWASAKI				SUZUKI				
			Ø 16	Ø 16	Ø 16	Ø 16	Ø 16	Ø 16	Ø 16	Ø 16	Ø 16	Ø 16	Ø 16	Ø 16	Ø 14	Ø 18	Ø 18	Ø 18	Ø 18
			02-07 CR 85	07-20 CRF 150	04-07 CR 250	09 CRF 250	10-17 CRF 250	18-23 CRF 250	17-23 CRF 450R	17-23 CRF 450X	09-19 KXF 250	15 KXF 450	16-18 KXF 450	19-23 KXF 450	02-20 RM 85	09 RMZ 250	10 RMZ 250	11-15 RMZ 250	09 RMZ 450
RMAN01601	SERVICE KIT RC	1				○					○		○						
RMAN01602	SERVICE KIT RC	1					○			○									
RMAN01603	SERVICE KIT RC	1									○								
RMAN01604	SERVICE KIT RC	1																	
RMAN01605	SERVICE KIT RC	1						○	○										
RMAN01606	SERVICE KIT RC	1											○						
RMAN01607	SERVICE KIT RC	1			○														
RMAN01801	SERVICE KIT RC	1													○				○
RMAN01802	SERVICE KIT RC	1														○			
RMAN01803	SERVICE KIT RC	1																	

SHOWA

by GENUINE PARTS EUROPE



CARTRIDGE KIT





CARTRIDGE KIT



CARTRIDGE KIT

Transform your WP XPLOR 48mm into high performance SHOWA TWIN CHAMBER forks
MADE IN JAPAN.

No axle holder replacement or disassembly needed.

Upgrade operational function and performance of your fork with the cartridge kit, pressurized system, no damping loss.

Designed using the suspension technology proven and fed back from the racing department.

Featuring Showa's cutting-edge technologies as Kashima coating.

Settings can be adjusted externally:
COMPRESION and REBOUND.

Part number: KITCRXP01 / KITCRAE01



CARTRIDGE KIT



CARTRIDGE KIT CONTENT

- 2 complete TWIN CHAMBER CARTRIDGE
- 2 ud BUSH ADAPTER SET
- 2 liters oil SS05

Part number: KITCRXP01 / KITCRAE01



CARTRIDGE KIT



TECHNICAL DETAILS

SHOWA TWIN CHAMBER technology.
35 mm Ø COMP PISTON
24 mm Ø REB PISTON
12,5 mm Ø ROD
Kashima coating main cylinder
Spring seat with slide bush.
OEM WP springs can be used.
Spring preload adjustable.
COMP & REB clickers.

Part number: KITCRXP01 / KITCRAE01



CARTRIDGE KIT



APPLICATION LIST

KITCRXP01 / ENDURO XPLOR

KTM

EXC / EXC-F / WC from 2017

HUSQVARNA

TE / FE from 2017

GASGAS

EC / EC-F from 2021

KITCRAE01 / MOTOCROSS XACT

KTM

SX / SX-F from 2016

HUSQVARNA

FC / TC from 2016

GASGAS

MC / MC-F from 2021



FRONT FORK PARTS





FRONT FORK 47 mm

CRF 250 09 / KXF 250 09-10 / RMZ 250 09-12 / RMZ 450 09-12

- OUTERTUBE
- SLIDEPIPE
- AXLEHOLDER



N	REFERENCE	NAME PART	QTY	09 CRF 250	09-10 KXF 250	09-12 RMZ 250	09-12 RMZ 450
1	FJ6557301	OUTER TUBE	2		○		
1	FJ6556801	OUTER TUBE	2			○	
1	FJ6556701	OUTER TUBE	2				○
1	FJ6500011	OUTER TUBE	2	○			
2	F36600001	STOPPER RING	2	○	○	○	○



N	REFERENCE	NAME PART	QTY	09 CRF 250	09-10 KXF 250	09-12 RMZ 250	09-12 RMZ 450
1	F30504701	SLIDE PIPE Ø47 L597mm	2		○	○	○
1	F30504702	SLIDE PIPE Ø47 L588mm	2	○			
2	F44904703	R AXLE HOLDER	1	○			
3	F44804703	L AXLE HOLDER	1	○			
3	F44904704	R AXLE HOLDER	1		○		
2	F44804704	L AXLE HOLDER	1		○		
2	F44904702	R AXLE HOLDER	1			○	○
3	F44804702	L AXLE HOLDER	1			○	○



FRONT FORK 47 mm

CRF 250 09 / KXF 250 09-10 / RMZ 250 09-12 / RMZ 450 09-12

- BUSH
- SEAL



N	REFERENCE	NAME PART	QTY	09 CRF 250	09-10 KXF 250	09-12 RMZ 250	09-12 RMZ 450
1	F27604702	SLIDE BUSH	2	○	○	○	○
2	F27504702	GUIDE BUSH	2	○	○	○	○
3	F35300004	SEAL SPASER	2	○	○	○	○
3	F35300003	SEAL SPASER	2	○	○	○	○
4	F32004701	OIL SEAL	2	○	○	○	○
5	F36500002	OIL SEAL STOPPER RING	2	○	○	○	○
6	F33004701	DUST SEAL	2	○	○	○	○



FRONT FORK 47 mm

CRF 250 09 / KXF 250 09-10 / RMZ 250 09-12 / RMZ 450 09-12

- PISTON ROD



N	REFERENCE	NAME PART	QTY	09	09	10	09	10-12	09	10-12
				CRF 250	KXF 250	KXF 250	RMZ 250	RMZ 250	RMZ 450	RMZ 450
1	F12041001	PISTON ROD COMP	2	○						
1	F12041502	PISTON ROD COMP	2		○					
1	F12041003	PISTON ROD COMP	2			○				
1	F12040001	PISTON ROD COMP	2				○			
1	F12040002	PISTON ROD COMP	2					○		○
1	F12040003	PISTON ROD COMP	2						○	
2	F30140501	ROD PIPE L=405.5 mm Ø12.5mm	2	○	○	○				
2	F30140001	ROD PIPE L=400 mm Ø12.5mm	2				○	○	○	○
3	F29900002	PUSH ROD	2	○	○	○				
3	F29900004	PUSH ROD	2				○	○	○	○
4	F27800002	ROD END	2	○	○	○				
4	F27800008	ROD END	2				○	○	○	○
5	F24022502	PISTON	2	○						
5	F24000001	PISTON	2		○					
5	F24022503	PISTON	2			○				
5	F24022501	PISTON	2				○	○	○	○
6	F55100601	NUT	2	○	○	○	○	○	○	○
7	F25002301	PISTON RING	2	○	○	○	○	○	○	○
8	F27600001	SLIDE BUSH	2	○	○	○	○	○	○	○
9	F34512502	PACKING	2	○	○	○	○	○	○	○
10	F34000018	O RING	2	○	○	○	○	○	○	○
11	* NO NAME	NEEDLE	2	○	○	○	○	○	○	○



FRONT FORK 47 mm

CRF 250 09 / KXF 250 09-10 / RMZ 250 09-12 / RMZ 450 09-12

- OIL LOCK
- FORK BOLT



N	REFERENCE	NAME PART	QTY	09 CRF 250	09 KXF 250	10 KXF 250	09-12 RMZ 250	09-12 RMZ 450
1	F27500001	GUIDE BUSH	2	○	○	○	○	○
2	F20900002	OIL LOCK VALVE	2	○	○	○	○	○
2	F20900001	OIL LOCK VALVE	2	○	○	○	○	○
3	F36800002	STOPPER RING C	2	○	○	○	○	○
4	F38500008	REB. SPG K=8.4N L=21.4mm	2	○	○	○	○	○

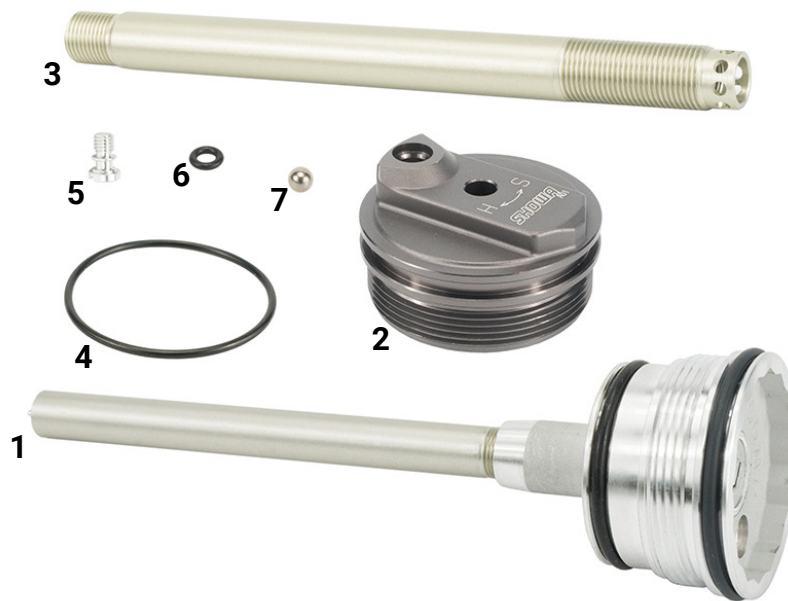

N	REFERENCE	NAME PART	QTY	09 CRF 250	09-10 KXF 250	09-12 RMZ 250	09-12 RMZ 450
1	F15600010	FORK BOLT COMP	2	○	○	○	○
1	F15600016	FORK BOLT COMP	2	○	○	○	○
2	F45000010	FORK BOLT	2	○	○	○	○
3	F83910001	SHAFT	2	○	○	○	○
3	F83910002	SHAFT	2	○	○	○	○
4	F34000006	O RING	2	○	○	○	○
5	F45300001	PLUG BOLT	2	○	○	○	○
6	F34000017	O RING	2	○	○	○	○
7	F20600001	BALL	2	○	○	○	○



FRONT FORK 47 mm

CRF 250 09 / KXF 250 09-10 / RMZ 250 09-12 / RMZ 450 09-12

- FREE PISTON

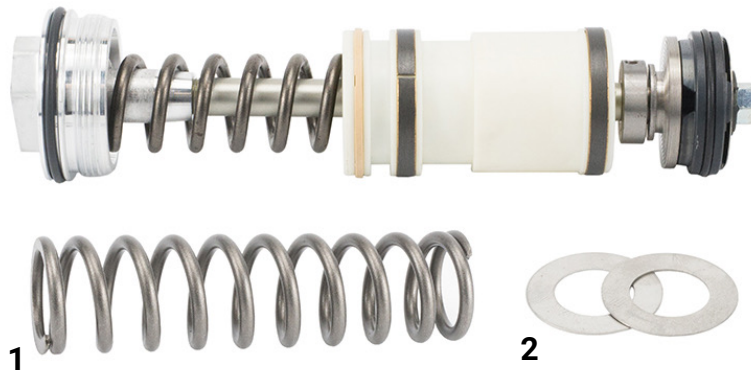

N	REFERENCE	NAME PART	QTY	09	09-10	09-12	09-12
				CRF 250	KXF 250	RMZ 250	RMZ 450
1	F38100005	SPG B K=17,6 N/mm L=100 mm	2		○		
1	F38100006	SPG B K=19.0 N/mm L=100 mm	2			○	○
1	F38100002	SPG B K=17,3 N/mm L=100 mm	2	○			
2	F57700001	SLAST WASHER	4	○	○	○	○

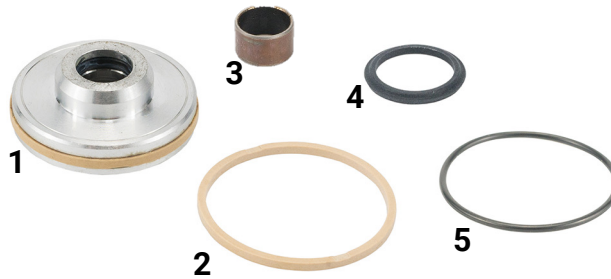

N	REFERENCE	NAME PART	QTY	09
				CRF 250
1	F86000001	FREE PISTON COMP	2	○
2	F25003401	PISTON RING	2	○
3	FH7500001	GUIDE BUSH B	2	○
4	FK4501002	PACKING B	2	○
5	F34000012	O RING	2	○



FRONT FORK 47 mm

CRF 250 09 / KXF 250 09-10 / RMZ 250 09-12 / RMZ 450 09-12

- FREE PISTON



N	REFERENCE	NAME PART	QTY	09-10 KXF 250	09-12 RMZ 250	09-12 RMZ 450
1	F36600002	STOPPER RING	2	<input type="checkbox"/>	<input type="checkbox"/>	<input type="checkbox"/>
2	FK7433401	SLID BUSH C	4	<input type="checkbox"/>	<input type="checkbox"/>	<input type="checkbox"/>
3	F34000015	O RING	2	<input type="checkbox"/>	<input type="checkbox"/>	<input type="checkbox"/>
4	F32201001	GAS SEAL	2	<input type="checkbox"/>	<input type="checkbox"/>	<input type="checkbox"/>
5	F86000005	FREE PISTON COMP	2	<input type="checkbox"/>	<input type="checkbox"/>	<input type="checkbox"/>



N	REFERENCE	NAME PART	QTY	09 CRF 250	09-10 KXF 250	09 RMZ 250	10-12 RMZ 250	09 RMZ 450	10-12 RMZ 450
1	F27A00002	ROD END B	2	<input type="checkbox"/>	<input type="checkbox"/>	<input type="checkbox"/>	<input type="checkbox"/>	<input type="checkbox"/>	<input type="checkbox"/>
1	F27A00012	ROD END B	2	<input type="checkbox"/>	<input type="checkbox"/>	<input type="checkbox"/>	<input type="checkbox"/>	<input type="checkbox"/>	<input type="checkbox"/>
1	F27A00013	ROD END B	2	<input type="checkbox"/>	<input type="checkbox"/>	<input type="checkbox"/>	<input type="checkbox"/>	<input type="checkbox"/>	<input type="checkbox"/>
1	F27A00014	ROD END B	2	<input type="checkbox"/>	<input type="checkbox"/>	<input type="checkbox"/>	<input type="checkbox"/>	<input type="checkbox"/>	<input type="checkbox"/>
2	F55100601	NUT,HEX	2	<input type="checkbox"/>	<input type="checkbox"/>	<input type="checkbox"/>	<input type="checkbox"/>	<input type="checkbox"/>	<input type="checkbox"/>
3	FL4000003	L PISTON	2	<input type="checkbox"/>	<input type="checkbox"/>	<input type="checkbox"/>	<input type="checkbox"/>	<input type="checkbox"/>	<input type="checkbox"/>
3	FL4000001	L PISTON	2	<input type="checkbox"/>	<input type="checkbox"/>	<input type="checkbox"/>	<input type="checkbox"/>	<input type="checkbox"/>	<input type="checkbox"/>
4	F34000004	O RING	2	<input type="checkbox"/>	<input type="checkbox"/>	<input type="checkbox"/>	<input type="checkbox"/>	<input type="checkbox"/>	<input type="checkbox"/>
5	F25002301	PISTON RING	2	<input type="checkbox"/>	<input type="checkbox"/>	<input type="checkbox"/>	<input type="checkbox"/>	<input type="checkbox"/>	<input type="checkbox"/>



FRONT FORK 47 mm

CRF 250 09 / KXF 250 09-10 / RMZ 250 09-12 / RMZ 450 09-12

- CENTER BOLT
- SPRING



N	REFERENCE	NAME PART	QTY	09	09-10	09-12	09-12
				CRF 250	KXF 250	RMZ 250	RMZ 450
1	F34000001	O RING	2	○	○	○	○
2	F41000001	LOCK NUT	2	○	○	○	○
3	FB2600003	CENTER BOLT COMP	2	○	○	○	○

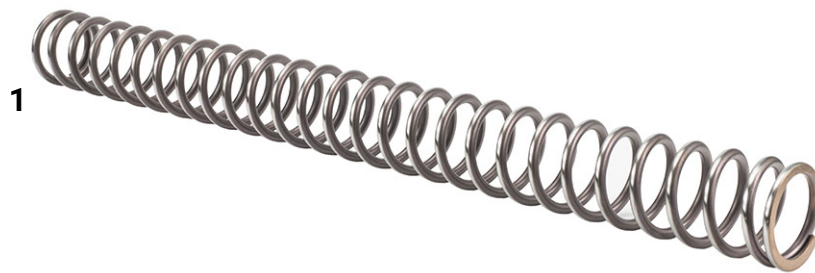

N	REFERENCE	NAME PART	QTY	09	09-10	09	10	11-12	09	10	11-12
				CRF 250	KXF 250	RMZ 250	RMZ 250	RMZ 250	RMZ 450	RMZ 450	RMZ 450
1	F38004402	SPRING K=4,4 N/mm L=494	2	○		○					
1	F38004501	SPRING K=4,5 N/mm L=495	2	○	○						
1	F38004602	SPRING K=4,6 N/mm L=494	2	○							
1	F38004702	SPRING K=4,7 N/mm L=495	2	○			○		○		
1	F38004802	SPRING K=4,7 N/mm L=496	2	○						○	
1	F38004701	SPRING K=4,61 N/mm L=495	2	○				○			
1	F38004801	SPRING K=4,71 N/mm L=494	2	○							○



FRONT FORK SFF 47 mm

KXF 250 11-12

- OUTERTUBE
- SLIDPIPE
- AXLEHOLDER

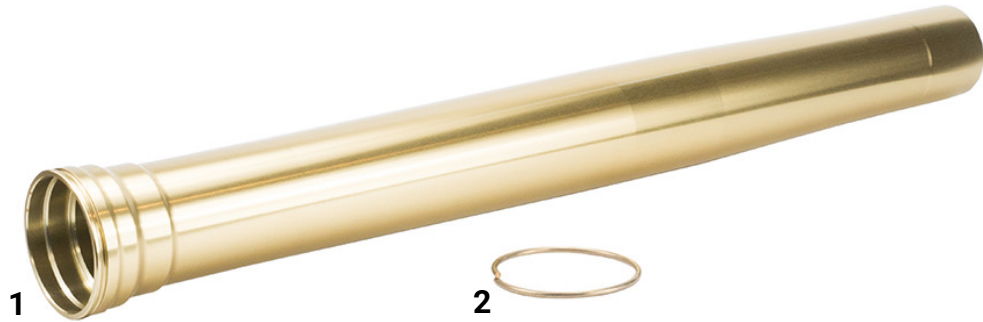

N	REFERENCE	NAME PART	QTY	11 KXF 250	12 KXF 250
1	FJ6557501	OUTER TUBE	2	<input type="radio"/>	<input type="radio"/>
2	F36600001	STOPPER RING	2	<input type="radio"/>	<input type="radio"/>
2	F36600003	STOPPER RING	2	<input type="radio"/>	<input type="radio"/>

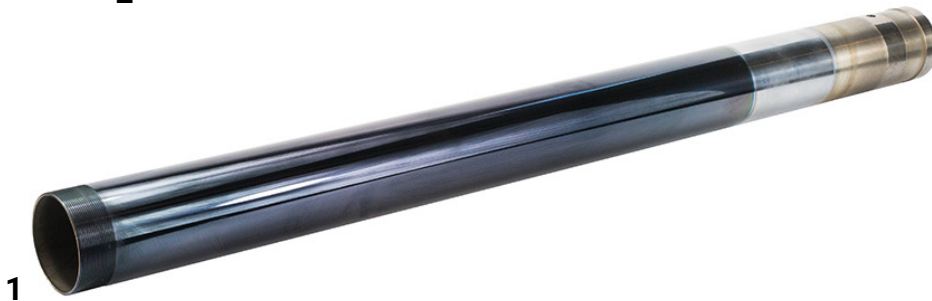

N	REFERENCE	NAME PART	QTY	11-12 KXF 250
1	F30504706	R SLIDE PIPE Ø47	2	<input type="radio"/>
2	F44904704	R AXLE HOLDER	1	<input type="radio"/>
3	F44804704	L AXLE HOLDER	1	<input type="radio"/>



FRONT FORK SFF 47 mm

KXF 250 11-12

- BUSH
- SEAL



N	REFERENCE	NAME PART	QTY	11-12 KXF 250
1	F27604702	SLIDE BUSH	2	○
2	F27504702	GUIDE BUSH	2	○
3	F35300003	SEAL SPASER	2	○
4	F32004701	OIL SEAL	2	○
5	F36500002	OIL SEAL STOPPER RING	2	○
6	F33004701	DUST SEAL	2	○



- PISTON ROD



N	REFERENCE	NAME PART	QTY	11-12 KXF 250
1	F12040801	PISTON ROD COMP	1	<input type="radio"/>
2	F30140801	ROD PIPE L=408mm Ø12.5mm	1	<input type="radio"/>
3	F29900002	PUSH ROD	1	<input type="radio"/>
4	F27800013	ROD END	1	<input type="radio"/>
5	F24027501	PISTON	1	<input type="radio"/>
6	F55100601	NUT,HEX	1	<input type="radio"/>
7	F25002801	PISTON RING	1	<input type="radio"/>
8	F34000019	O RING	1	<input type="radio"/>
9	F34512501	PACKING	1	<input type="radio"/>
10	F35201801	BACK UP RING	1	<input type="radio"/>
11	-	NEEDLE	1	<input type="radio"/>



FRONT FORK SFF 47 mm

KXF 250 11-12

- OIL LOCK
- FORK BOLT



N	REFERENCE	NAME PART	QTY	11 KXF 250	12 KXF 250
1	F27500001	GUIDE BUSH	1	<input type="radio"/>	<input type="radio"/>
2	F20900004	OIL LOCK VALVE	1	<input type="radio"/>	<input type="radio"/>
3	F36800001	STOPPER RING C	1	<input type="radio"/>	<input type="radio"/>
4	F38500002	REB.SPG. K=21.6N/mm L=25.5mm R.	1	<input type="radio"/>	<input type="radio"/>
4	F38500003	REB.SPG. K=23.5N/mm L=60mm L.	1	<input type="radio"/>	<input type="radio"/>
4	F38500004	REB.SPG. K=11.1N/mm L=58.3mm R.	1	<input type="radio"/>	<input type="radio"/>
4	F38500005	REB.SPG. K=19.1N/mm L=28.1mm L.	1	<input type="radio"/>	<input type="radio"/>

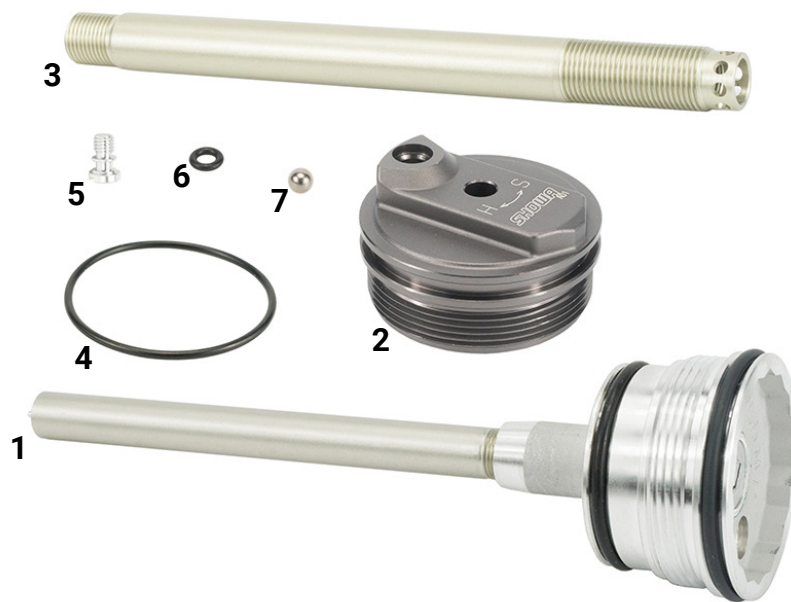

N	REFERENCE	NAME PART	QTY	11-12 KXF 250
1	F15600004	FORK BOLT COMP	1	<input type="radio"/>
2	F45000002	FORK BOLT	1	<input type="radio"/>
3	F83910002	SHAFT	1	<input type="radio"/>
4	F34000006	O RING	1	<input type="radio"/>
5	F45300001	PLUG BOLT	2	<input type="radio"/>
6	F34000017	O RING	2	<input type="radio"/>
7	-	BALL	2	<input type="radio"/>



- FREE PISTON

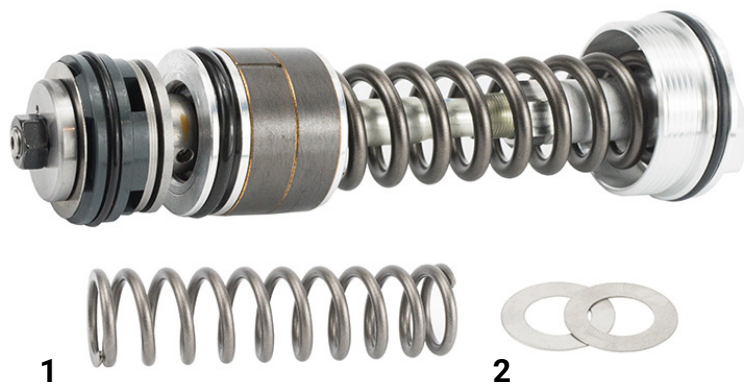

N	REFERENCE	NAME PART	QTY	11-12 KXF 250
1	F38100009	SPG B K=23.4 N/mm L=99 mm	1	○
2	F57700001	SLAST WASHER	2	○
-	F36800002	STOPPER RING B	1	○
-	F75000001	SLAST LACE	1	○
-	F34000014	O RING	1	○



FRONT FORK SFF 47 mm

KXF 250 11-12

- FREE PISTON



N	REFERENCE	NAME PART	QTY	11-12 KXF 250
1	F36800002	STOPPER RING	1	<input type="radio"/>
2	FK7433401	SLID BUSH C	2	<input type="radio"/>
3	F34000015	O RING	1	<input type="radio"/>
4	F32201001	GAS SEAL	1	<input type="radio"/>



N	REFERENCE	NAME PART	QTY	11-12 KXF 250
1	F27A00002	ROD END B	1	<input type="radio"/>
2	F55100601	NUT,HEX	2	<input type="radio"/>
3	FL4000001	L PISTON	1	<input type="radio"/>
4	F34000004	O RING	1	<input type="radio"/>
5	F25002801	PISTON RING	1	<input type="radio"/>



FRONT FORK SFF 47 mm

KXF 250 11-12

- CENTER BOLT
- SPRING



N	REFERENCE	NAME PART	QTY	11-12 KXF 250
1	F34000001	O RING	2	○
2	F41000001	LOCK NUT	1	○
3	FB2600003	CENTER BOLT COMP	1	○



N	REFERENCE	NAME PART	QTY	11-12 KXF 250
1	F38008701	SPRING K=8.7N/mm L=740 mm	1	
1	F38009101	SPRING K=9.1N/mm L=740 mm	1	○
1	F38009501	SPRING K=9.5N/mm L=740 mm	1	
1	F38009901	SPRING K=9.9N/mm L=740 mm	1	



N	REFERENCE	NAME PART	QTY	11-12 KXF 250
1	F12A00001	TENSION ROD COMP	1	○
2	F25002001	PISTON RING	1	○
3	FB2600002	CENTER BOLT COMP	1	○
-	F75300001	SLAST PLATE	1	○
-	FR3700001	THRUST WASHER STOPPER RING	1	○



FRONT FORK 48 mm

CRF 250 10-14

- OUTERTUBE
- SLIDPIPE
- AXLEHOLDER

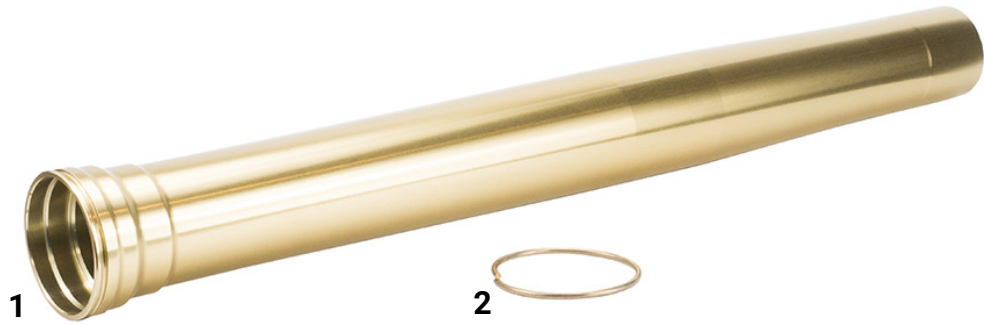

N	REFERENCE	NAME PART	QTY	10-14 CRF 250
1	FJ6557101	OUTER TUBE	2	○
2	F36600001	STOPPER RING	2	○



N	REFERENCE	NAME PART	QTY	10 CRF 250	11-12 CRF 250	13-14 CRF 250
1	F30504801	R SLIDE PIPE Ø48 L=590mm	2	○	○	○
2	F44904801	R AXLE HOLDER	1	○	○	○
3	F44804801	L AXLE HOLDER	1	○	○	
3	F44804802	L AXLE HOLDER	1			○



FRONT FORK 48 mm

CRF 250 10-14

- BUSH
- SEAL



N	REFERENCE	NAME PART	QTY	10 CRF 250	11-12 CRF 250	13-14 CRF 250
1	F27604801	SLIDE BUSH	2	○	○	○
2	F27504801	GUIDE BUSH	2	○	○	○
3	F35300001	SEAL SPACER	2	○		
3	F35300002	SEAL SPACER	2		○	○
4	F32004801	OIL SEAL	2	○	○	○
5	F36500001	OIL SEAL STOPPER RING	2	○	○	○
6	F33004801	DUST SEAL	2	○	○	○



- PISTON ROD



N	REFERENCE	NAME PART	QTY	10 CRF 250	11-14 CRF 250
1	F12039601	PISTON ROD COMP	2	○	
1	F12039602	PISTON ROD COMP	2		○
2	F30139601	ROD PIPE L=396mm Ø12.5m	2	○	
2	F30139602	ROD PIPE L=396mm Ø12.5m	2		○
3	F29900003	PUSH ROD	2	○	○
4	F27800014	ROD END	2	○	
4	F27800001	ROD END	2		○
5	F24002301	PISTON	2	○	○
6	F55100601	NUT	2	○	○
7	F25002401	PISTON RING	2	○	○
8	F27512001	GUIDE BUSH	2	○	
8	F27512501	GUIDE BUSH	2		○
9	F34512501	PACKING	2	○	○
10	F35201801	BACK UP RING	2	○	○
11	F51300002	ADJUST BOLT	1		○
12	F34000003	O RING	2	○	○
13	F34000013	O RING	1		○



- FORK BOLT

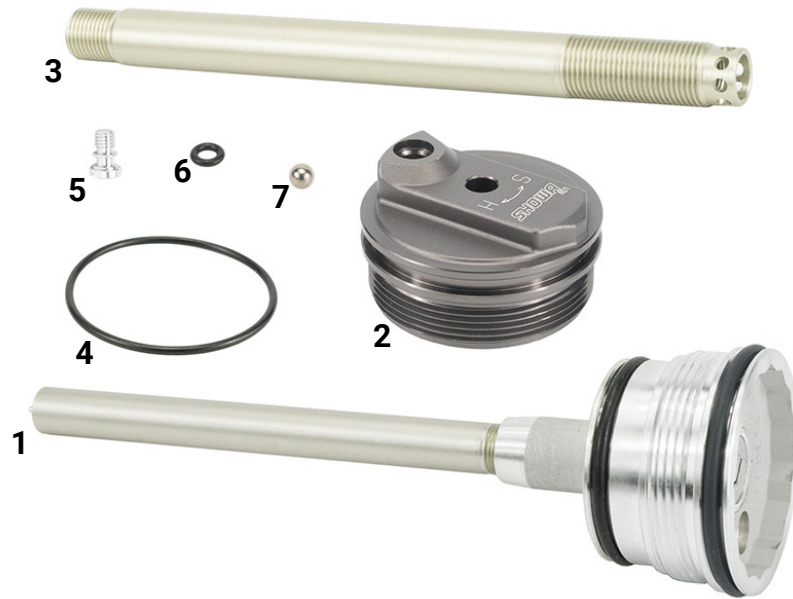

N	REFERENCE	NAME PART	QTY	10 CRF 250	11-14 CRF 250
1	F15600008	FORK BOLT COMP	2	○	
1	F15600002	FORK BOLT COMP	2		○
2	F45000005	FORK BOLT	2	○	
2	F45000001	FORK BOLT	2		○
3	F83900001	SHAFT	2	○	
3	F83912701	SHAFT	2		○
4	F34000007	O RING FORK BOLT TOP	2	○	○
4	F34000005	O RING FORK BOLT INSIDE	2	○	
5	F45300002	PLUG BOLT LONG	2	○	
6	F34000013	O RING	2	○	
5	F45300004	PLUG BOLT GOLD	2	○	
6	F34000017	O RING	2	○	
5	F45300003	PLUG BOLT	2		○
6	F34000017	O RING	2		○



FRONT FORK 48 mm

CRF 250 10-14

- OIL LOCK
- FREE PISTON



N	REFERENCE	NAME PART	QTY	10-14 CRF 250
1	F20900003	OIL LOCK VALVE	2	○
2	F36800002	STOPPER RING C	2	○
3	F38500001	REB SPG K=0.7N/mm L=19mm	2	○

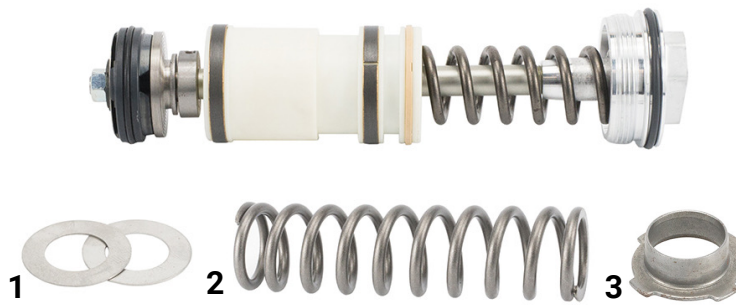

N	REFERENCE	NAME PART	QTY	10 CRF 250	11-14 CRF 250
1	F57700001	SLAST WASHER	2	○	○
2	F38100003	SPG B K=21.5N/mm L=105mm	2	○	○
2	F38100004	SPG B K=20.5N/mm L=96mm	2	○	○
3	F40000001	SPG GUIDE	4	○	○
3	F40000001	SPG GUIDE	2	○	○



- FREE PISTON



N	REFERENCE	NAME PART	QTY	10 CRF 250	11-12 CRF 250	13-14 CRF 250
1	F86000002	FREE PISTON COMP	2	○		
1	F86000003	FREE PISTON COMP	2		○	
1	F86000004	FREE PISTON COMP	2			○
3	FK4501001	PACKING B	2	○	○	○
4	F34000010	O RING	1		○	○
4	F34000016	O RING	4	○		
5	F25003801	PISTON RING	1		○	○
5	FS7700001	BACKUP RING B	2	○		
6	FK7436901	SLID BUSH C	2	○		
6	FK7437601	SLID BUSH C	4		○	○
6	FK7333501	SLIDE BUSH B	2	○		



- FREE PISTON



N	REFERENCE	NAME PART	QTY	10 CRF 250	11-12 CRF 250	13-14 CRF 250
1	F27A00015	ROD END B	2	○		
1	F27A00001	ROD END B	2		○	○
2	F55100601	NUT,HEX	2	○	○	○
3	FL4000002	L PISTON	2	○	○	
3	FL4000004	L PISTON	2			○
4	F34000021	O RING	2	○	○	
4	F34000011	O RING	2			○
5	F25002401	PISTON RING	2	○	○	○
-	F18000002	ADJUST ROD COMP.	2		○	○



FRONT FORK 48 mm

CRF 250 10-14

- CENTER BOLT
- SPRING



N	REFERENCE	NAME PART	QTY	10-14 CRF 250
1	F34000002	O RING	2	○
2	F41000001	LOCK NUT	2	○
3	FB2600001	CENTER BOLT COMP	2	○



N	REFERENCE	NAME PART	QTY	10-12 CRF 250	13-14 CRF 250
1	F38004201	SPRING K=4.2N/mm L=460mm	2		
1	F38004401	SPRING K=4.4N/mm L=460mm	2	○	
1	F38004601	SPRING K=4.6N/mm L=460mm	2		○



FRONT FORK SFF 48 mm

KXF 250 13-18 / RMZ 250 13-15 / RMZ 450 13-14

- OUTERTUBE

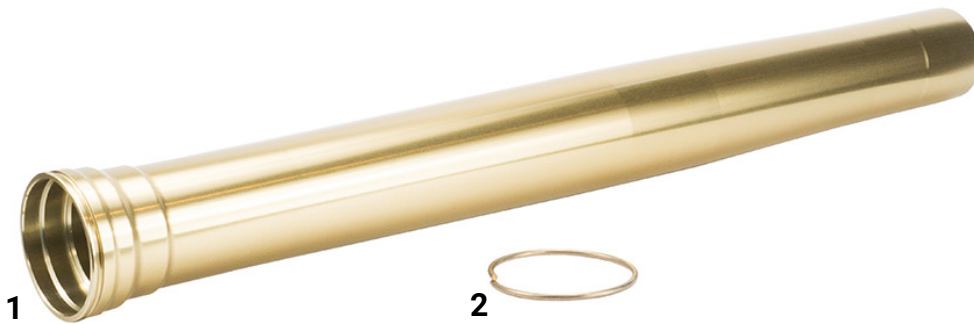

N	REFERENCE	NAME PART	QTY	13-14	15-19	13-15	13-14
				KXF 250	KXF 250	RMZ 250	RMZ 450
1	FJ6556501	OUTER TUBE	2	o			
1	FJ6556504	OUTER TUBE	2		o		
1	FJ6556503	OUTER TUBE	2			o	
1	FJ6556502	OUTER TUBE	2				o
2	F36600003	STOPPER RING	2	o	o		
2	F36600001	STOPPER RING	2			o	o



FRONT FORK SFF 48 mm

KXF 250 13-18 / RMZ 250 13-15 / RMZ 450 13-14

- SLIDEPIPE
- AXLEHOLDER



N	REFERENCE	NAME PART	QTY	13-14	15-16	17-19	13-15	13-14
				KXF 250	KXF 250	KXF 250	RMZ 250	RMZ 450
1	F30604801	L SLIDE PIPE Ø48 L=600mm	1	o	o			
1	F30604803	L SLIDE PIPE Ø48	1			o		
1	F30504806	R SLIDE PIPE Ø48	1			o		
1	F30504805	R SLIDE PIPE Ø48 L=595mm	1				o	
1	F30604802	L SLIDE PIPE Ø48 L=595mm	2				o	o
1	F30504804	R SLIDE PIPE Ø48 L=595mm	1					o
2	F44904802	R AXLE HOLDER	1	o	o	o		
2	F44904805	R AXLE HOLDER	1				o	o
3	F44804803	L AXLE HOLDER	1	o	o	o		
3	F44804806	L AXLE HOLDER	1				o	o



FRONT FORK SFF 48 mm

KXF 250 13-18 / RMZ 250 13-15 / RMZ 450 13-14

- BUSH
- SEAL



N	REFERENCE	NAME PART	QTY	13-19 KXF 250	13-15 RMZ 250	13-14 RMZ 450
1	F27604801	SLIDE BUSH	2	o	o	o
2	F27504801	GUIDE BUSH	2	o	o	o
3	F35300002	SEAL SPASER	2	o	o	o
4	F32004802	OIL SEAL	2	o	o	o
5	F36500001	OIL SEAL STOPPER RING	2	o	o	o
6	F33004802	DUST SEAL	2	o	o	o



FRONT FORK SFF 48 mm

KXF 250 13-18 / RMZ 250 13-15 / RMZ 450 13-14

- PISTON ROD



N	REFERENCE	NAME PART	QTY	13-16	17-19	13-15	13-14
				KXF 250	KXF 250	RMZ 250	RMZ 450
1	F12039001	PISTON ROD COMP	1	o		o	o
1	F12000006	PISTON ROD COMP	1		o		
2	F30139001	ROD PIPE L=390mmØ12.5mm	1	o	o	o	o
3	F29900005	PUSH ROD	1	o	o	o	o
4	F27800004	ROD END	1	o	o		
4	F27800005	ROD END	1			o	o
5	F24003001	PISTON	1	o		o	o
5	F24003002	PISTON	1		o		
6	F55100601	NUT	1	o	o	o	o
7	F25003001	PISTON RING	1	o	o	o	o
9	F34512501	PACKING	1	o	o	o	o
10	F35201801	BUCK UP RING	1	o	o	o	o
11	F51300002	ADJUST BOLT	1	o	o	o	o
12	F34000020	O RING	1	o	o	o	o
13	F34000013	O RING	1	o	o	o	o



FRONT FORK SFF 48 mm

KXF 250 13-18 / RMZ 250 13-15 / RMZ 450 13-14

- OIL LOCK
- FORK BOLT



N	REFERENCE	NAME PART	QTY	13-16	17-19	13-15	13-14
				KXF 250	KXF 250	RMZ 250	RMZ 450
1	FH7500002	GUIDE BUSH B	2	o	o		
2	F20900005	OIL LOCK VALVE	1	o			
2	F20900006	OIL LOCK VALVE	1			o	o
2	F20900007	OIL LOCK VALVE	1		o		
3	F38500006	REB. SPG. K=37.5N/mm SFFside	1	o	o	o	o
3	F38500007	REB. SPG. K=47.1N/mm FF side	1	o	o	o	o

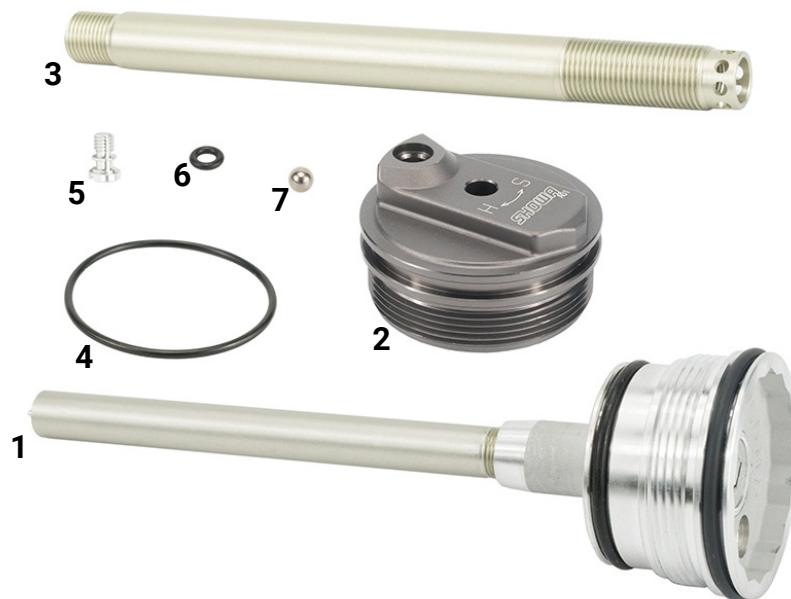

N	REFERENCE	NAME PART	QTY	13-14	15-16	17-19	13-15	13-14
				KXF 250	KXF 250	KXF 250	RMZ 250	RMZ 450
1	F15600013	FORK BOLT COMP	1	o				
1	F15600014	FORK BOLT COMP	1		o			
1	F15600003	FORK BOLT COMP	1				o	o
2	F45000003	FORK BOLT	1	o				
2	F45000007	FORK BOLT	1		o			
2	F45000014	FORK BOLT	1			o		
2	F45000004	FORK BOLT	1				o	o
3	F83912901	SHAFT	1	o	o	o	o	o
4	F34000017	O RING	2	o	o	o	o	o
5	F45300003	PLUG BOLT	2	o	o	o	o	o
6	F34000007	O RING	2	o	o	o	o	o



FRONT FORK SFF 48 mm

KXF 250 13-18 / RMZ 250 13-15 / RMZ 450 13-14

- FREE PISTON

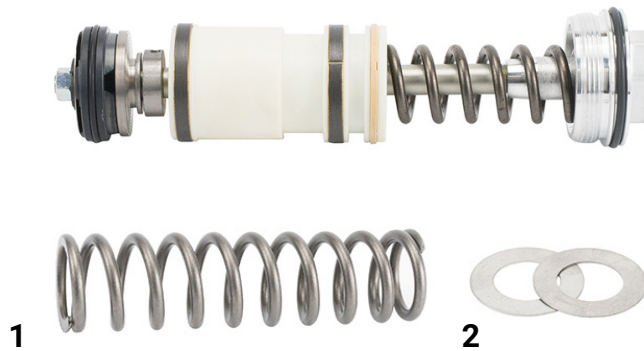

N	REFERENCE	NAME PART	QTY	13-14	15-16	17-19	13-15	13-14
				KXF 250	KXF 250	KXF 250	RMZ 250	RMZ 450
1	F38100010	SPG K=27.9 N/mm L=99	1	○	○		○	
1	F38100009	SPG K=23.4 N/mm L=99	1			○		
1	F38100014	SPG B K=34,7 N/mm L=99	1					○
2	F57700001	SLAST WASHER	1	○	○	○	○	○



N	REFERENCE	NAME PART	QTY	13-19	13-15	13-14
				KXF 250	RMZ 250	RMZ 450
1	F40000002	SPG GUIDE	1	○	○	○
-	F18621701	SPG COLLAR COMP	1	○		
-	F18621201	SPG COLLAR COMP	1		○	○



FRONT FORK SFF 48 mm

KXF 250 13-18 / RMZ 250 13-15 / RMZ 450 13-14

- FREE PISTON



N	REFERENCE	NAME PART	QTY	13-19	13-15	13-14
				KXF 250	RMZ 250	RMZ 450
1	F86000006	FREE PISTON COMP	1	o	o	o
3	FK4501001	PACKING B	1	o	o	o
4	F34000010	O RING	1	o	o	o
5	F25003801	PISTON RING	1	o	o	o
6	FK7437601	SLIDE BUSH C	4	o	o	o

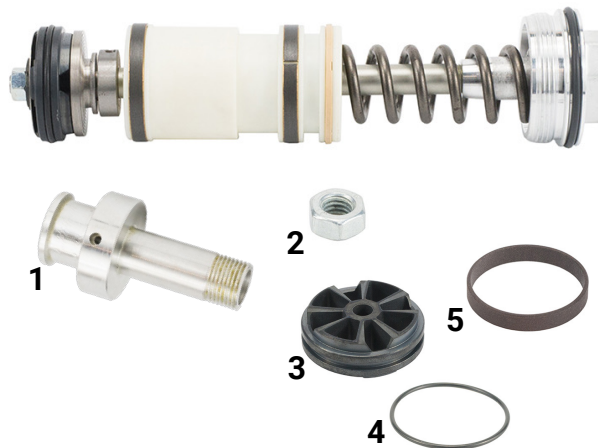

N	REFERENCE	NAME PART	QTY	13-19	13-15	13-14
				KXF 250	RMZ 250	RMZ 450
1	F27A00003	ROD END B	1	o		
1	F27A00004	ROD END B	1		o	o
2	F55100601	NUT,HEX	1	o	o	o
3	FL4000002	L PISTON	1	o	o	o
4	F34000021	O RING	1	o	o	o
5	F25003001	PISTON RING	1	o	o	o
-	F18000002	ADJUST ROD COMP.	1	o	o	o



FRONT FORK SFF 48 mm

KXF 250 13-18 / RMZ 250 13-15 / RMZ 450 13-14

- CENTER BOLT
- SPRING



N	REFERENCE	NAME PART	QTY	13-19 KXF 250	13-15 RMZ 250	13-14 RMZ 450
1	F34000002	O RING	2	○	○	○
2	F41000001	LOCK NUT	2	○	○	○
3	FB2600001	CENTER BOLT COMP	1	○	○	○



N	REFERENCE	NAME PART	QTY	13-14 KXF 250	15-16 KXF 250	17 KXF 250	18-19 KXF 250	13-15 RMZ 250	13-14 RMZ 450
1	F38009401	SPRING K=9,4 N/mm L=660	1	○			○		
1	F38009001	SPRING K=9,0 N/mm L=660	1						
1	F38009801	SPRING K=9,8 N/mm L=660	1			○			
1	F38009601	SPRING K=9,6 N/mm L=660	1		○				
1	F38009201	SPRING K=9,2 N/mm L=660	1						
1	F38010001	SPRING K=10,0 N/mm L=660	1						
1	F38009802	SPRING K=9,8 N/mm L=660	1					○	○
1	F38009402	SPRING K=9,4 N/mm L=660	1						
1	F38010201	SPRING K=10,2 N/mm L=660	1						



FRONT FORK SFF 48 mm

KXF 250 13-18 / RMZ 250 13-15 / RMZ 450 13-14

- PISTON ROD



N	REFERENCE	NAME PART	QTY	13-14	15-19	13-15	13-14
				KXF 250	KXF 250	RMZ 250	RMZ 450
1	F12A00007	TENSION ROD COMP	1	o	o	o	o
2	F25002301	PISTON RING	1	o	o	o	o
3	FG1500001	CENTER BOLT	1	o		o	o
3	FG1500002	CENTER BOLT	1		o		
4	F27800003	ROD END	1	o	o	o	o
5	F34000002	O RING	1	o	o	o	o



FRONT FORK SFF 49 mm

CRF 250 15-17 / KXF 450 15-18 / RMZ 450 15-17

- OUTERTUBE
- SLIDPIPE
- AXLEHOLDER

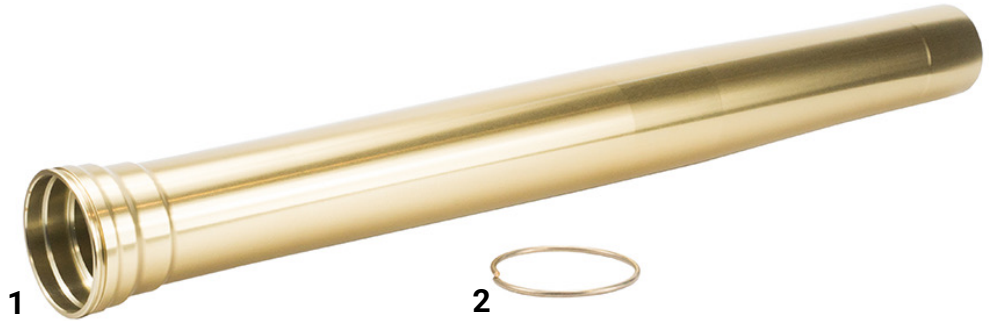

N	REFERENCE	NAME PART	QTY	15 CRF 250	16-17 CRF 250	15-16 KXF 450	17-18 KXF 450	15-17 RMZ 450
1	FJ6500001	OUTER TUBE	2	○	○	○	○	○
1	FJ6500003	OUTER TUBE						○
1	FJ6500004	OUTER TUBE	2		○			
1	FJ6500005	OUTER TUBE					○	
2	F36600004	STOPPER RING	2	○	○	○	○	○

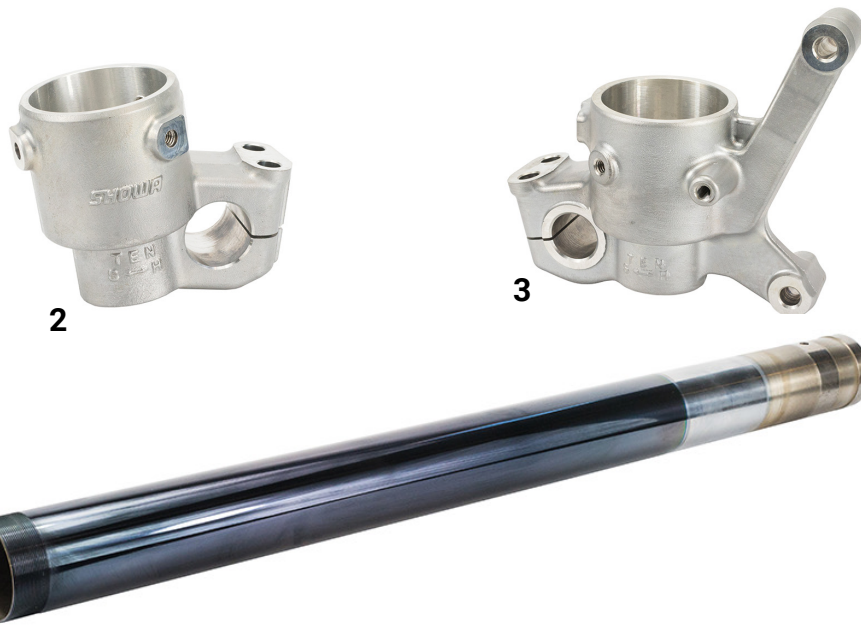

N	REFERENCE	NAME PART	QTY	15 CRF 250	16-17 CRF 250	15 KXF 450	16 KXF 450	17-18 KXF 450	15-17 RMZ 450
1	F30504901	R SLIDE PIPE Ø49 L=595mm	2	○					
1	F30504902	R SLIDE PIPE Ø49 L=600mm	2			○			
1	F30504903	R SLIDE PIPE Ø49	2						○
1	F30504904	R SLIDE PIPE Ø49	2		○				
1	F30504905	R SLIDE PIPE Ø49	2				○	○	
2	F44904901	R AXLE HOLDER	1	○	○				
2	F44904902	R AXLE HOLDER	1			○	○	○	
2	F44904903	R AXLE HOLDER	1						○
3	F44804901	L AXLE HOLDER	1	○	○				
3	F44804902	L AXLE HOLDER	1			○	○	○	
3	F44804903	L AXLE HOLDER	1						○



FRONT FORK SFF 49 mm

CRF 250 15-17 / KXF 450 15-18 / RMZ 450 15-17

- BUSH
- SEAL



N	REFERENCE	NAME PART	QTY	15-17	15-18	15-17
				CRF 250	KXF 450	RMZ 450
1	F27604901	SLIDE BUSH	2	○	○	○
2	F27504901	GUIDE BUSH	2	○	○	○
3	F35300005	SEAL SPACER	2	○		
3	F35300006	SEAL SPACER	2		○	○
4	F32004901	OIL SEAL	2	○	○	○
5	F36500003	OIL SEAL STOPPER RING	2	○	○	○
6	F33004901	DUST SEAL	2		○	
6	F33004902	DUST SEAL	2			○
6	F33004903	DUST SEAL	2	○		



FRONT FORK SFF 49 mm

CRF 250 15-17 / KXF 450 15-18 / RMZ 450 15-17

- REBOUND SPRING



N	REFERENCE	NAME PART	QTY	15-17 CRF 250	15 KXF 450	16 KXF 450	17-18 KXF 450	15-17 RMZ 450
1	F39000001	REB.SPG.B K=127N/mm L=23.9mm	1	○	○			○
1	F39000002	REB SPG B K=91N/mm L=31.4mm	1	○		○		
1	F39000003	REB SPG B K=87.3N/mm L=31.4mm	1				○	
1	F38500009	REB.SPG. K=67N/mm L=17.4mm	1		○			○
1	F38500010	REB SPG K=140N/mm L=23.1 mm	1			○		
1	F38500012	REB SPG K=138N/mm L=23 mm	1				○	



FRONT FORK SFF 49 mm

CRF 250 15-17 / KXF 450 15-18 / RMZ 450 15-17

- PISTON ROD



N	REFERENCE	NAME PART	QTY	15 CRF 250	16-17 CRF 250	15 KXF 450	16 KXF 450	17-18 KXF 450	15-17 RMZ 450
1	F12000001	PISTON ROD COMP	1	○					
1	F12000002	PISTON ROD COMP				○			
1	F12000003	PISTON ROD COMP							○
1	F12000004	PISTON ROD COMP					○		
1	F12000005	PISTON ROD COMP	1		○				
1	F12000008	PISTON ROD COMP						○	
2	F30100001	ROD PIPE L=395 mm 14mm				○	○		○
2	F30100002	ROD PIPE L=390mm Ø14mm	1	○	○			○	
2	F30100003	ROD PIPE							
3	F29900005	PUSH ROD				○	○		○
3	F29900006	PUSH ROD	1	○	○				
3	F29900007	PUSH ROD						○	



FRONT FORK SFF 49 mm

CRF 250 15-17 / KXF 450 15-18 / RMZ 450 15-17

- ROD



N	REFERENCE	NAME PART	QTY	15	16-17	15	16	17-18	15-17
				CRF 250	CRF 250	KXF 450	KXF 450	KXF 450	RMZ 450
1	F27800006	ROD END	1						o
1	F27800007	ROD END	1	o		o			
1	F27800009	ROD END	1		o				
1	F27800010	ROD END	1				o		
1	F27800012	ROD END	1					o	
2	F24003002	PISTON	1			o		o	o
2	F24003003	PISTON	1	o					
2	F24003004	PISTON	1		o				
3	F55100801	NUT,HEX	1					o	
3	F55100601	NUT,HEX	1	o	o	o	o		o
4	F25003001	PISTON RING	2	o	o				
5	FH7500003	GUIDE BUSH B	2	o	o	o	o	o	o
6	FE9300001	ROD PACKING	1	o		o			o
6	FE9300002	ROD PACKING	1		o		o	o	
7	FS0000001	BACK UP RING C	1	o	o	o			o
8	F51300003	ADJUSTER	1	o	o	o	o	o	o
9	F34000020	O RING	2	o					
9	F34000020	O RING	1		o	o	o	o	o
10	F34000023	O RING	1	o	o	o	o	o	o
11	F20900005	OIL LOCK VALVE	1	o					
11	F20900006	OIL LOCK VALVE	1		o		o	o	



FRONT FORK SFF 49 mm

CRF 250 15-17 / KXF 450 15-18 / RMZ 450 15-17

- FORK BOLT



N	REFERENCE	NAME PART	QTY	15	16-17	15	16	17-18	15-17
				CRF 250	CRF 250	KXF 450	KXF 450	KXF 450	RMZ 450
1	F15600005	FORK BOLT COMP	1						o
1	F15600015	FORK BOLT COMP						o	
1	F15600006	FORK BOLT COMP	1			o			
1	F15600007	FORK BOLT COMP	1	o					
1	F15600011	FORK BOLT COMP	1		o				
1	F15600012	FORK BOLT COMP	1				o		
2	F45000006	FORK BOLT	1	o	o				
2	F45000008	FORK BOLT	1			o	o		
2	F45000009	FORK BOLT	1						o
2	F45000015	FORK BOLT	1					o	
3	F83900002	SHAFT	1	o		o	o		o
3	F83900003	SHAFT	1		o				
3	F83900004	SHAFT	1					o	



FRONT FORK SFF 49 mm

CRF 250 15-17 / KXF 450 15-18 / RMZ 450 15-17

- FREE PISTON



N	REFERENCE	NAME PART	QTY	15	16-17	15	16	17-18	15-17
				CRF 250	CRF 250	KXF 450	KXF 450	KXF 450	RMZ 450
1	F38100014	SPG B K=34.7N/mm L=99mm	1						o
1	F38100015	SPG B K=22.8N/mm L=100mm	1	o					
1	F38100016	SPG B K=28N/mm L=100 mm	1			o	o	o	
1	F38100017	SPG B K=32N/mm L=100mm	1		o				
2	F27A00005	ROD END B	1	o	o				
2	F27A00006	ROD END B	1			o	o		
2	F27A00007	ROD END B	1						o
2	F27A00009	ROD END B	1					o	
3	F55100801	NUT,HEX	1					o	
3	F55101201	NUT,HEX	1	o	o	o	o		o
4	FL4000005	PISTON L	1	o	o	o	o		o
4	FL4000006	PISTON L	1					o	
5	F34000029	O RING	1	o	o	o	o		o
5	F34000035	O RING	1					o	
6	F34000026	O RING	1	o	o	o	o	o	
7	F45300001	PLUG BOLT	1	o	o	o	o	o	
8	F34000017	O RING	1	o	o	o	o	o	
9	F51000001	SHAFT NUT	1			o	o	o	
10	F38700001	SET SPRING	1	o	o	o	o	o	o
11	F20600001	BALL	1	o	o	o	o	o	o
-	FK5000001	ADJUSTER ROD B	1	o	o	o	o	o	o



FRONT FORK SFF 49 mm

CRF 250 15-17 / KXF 450 15-18 / RMZ 450 15-17

- FREE PISTON



N	REFERENCE	NAME PART	QTY	15 CRF 250	16-17 CRF 250	15 KXF 450	16 KXF 450	17-18 KXF 450	15-17 RMZ 450
1	F86000007	FREE PISTON COMP	1	○	○				
1	F86000008	FREE PISTON COMP	1		○	○	○		○
1	F86000009	FREE PISTON COMP						○	
3	F32200001	GAS SEAL						○	
3	FK4500001	PACKING B	1	○	○	○	○		○
4	F34000025	O RING	1	○	○	○	○		○
4	F34000012	O RING						○	
5	F25200001	PISTON RING B	1	○	○	○	○		○
5	F25003401	PISTON RING B						○	
6	FK7433601	SLID BUSH C						○	
6	FK7400001	SLID BUSH C	2	○	○	○	○		○
-	F36600005	STOPPER RING						○	
-	F35300008	SEAL SPACER	2					○	



FRONT FORK SFF 49 mm

CRF 250 15-17 / KXF 450 15-18 / RMZ 450 15-17

- CENTER BOLT
- SPRING



N	REFERENCE	NAME PART	QTY	15	16-17	15	16	17-18	15-17
				CRF 250	CRF 250	KXF 450	KXF 450	KXF 450	RMZ 450
1	F34000028	O RING	1	○	○	○	○	○	○
2	F41000002	LOCK NUT	2	○	○	○	○	○	○
3	FB2600004	CENTER BOLT COMP	1	○	○	○	○	○	○
3	FB2600005	CENTER BOLT COMP				○	○		○
3	FB2600006	CENTER BOLT COMP	1		○				



N	REFERENCE	NAME PART	QTY	15	16-17	15-18	15-17
				CRF 250	CRF 250	KXF 450	RMZ 450
1	FNGL00001	SEALING BOLT	1	○	○		
1	FNGL00002	SEALING BOLT	1			○	○
2	F34000022	O RING	1	○	○	○	○
2	F34000027	O RING	1			○	○
3	F41000002	LOCK NUT	1	○	○	○	○
4	F34000004	O RING	1	○	○	○	○
5	F45600001	CAP,AIR VALVE	1	○	○		
6	F46800001	AIR VALVE CORE	1	○	○	○	○



FRONT FORK SFF 49 mm

CRF 250 15-17 / KXF 450 15-18 / RMZ 450 15-17

- FORK BOLT COMP

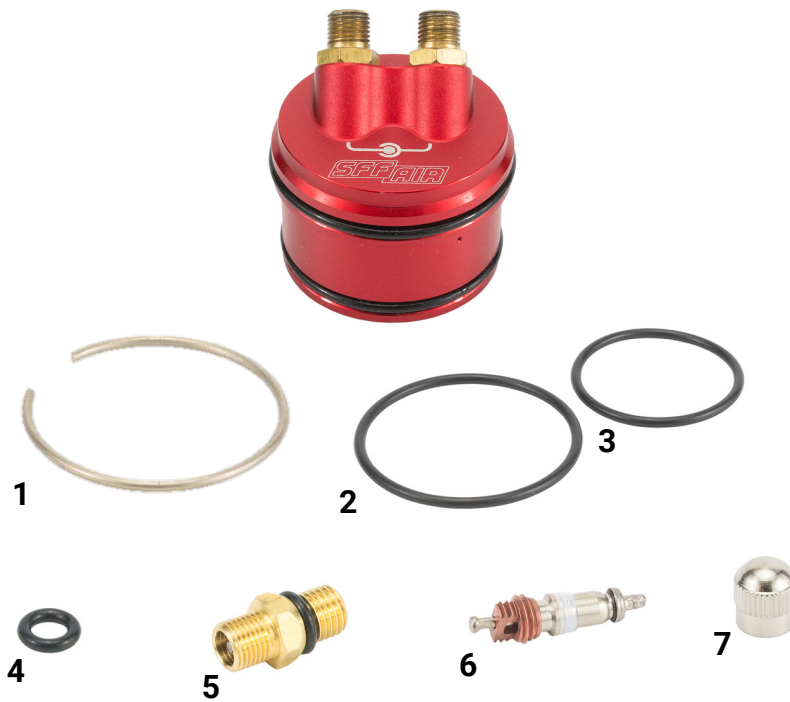

N	REFERENCE	NAME PART	QTY	15-17	15-18	15-17
				CRF 250	KXF 450	RMZ 450
1	F36700002	STOPPER RING B	1	○	○	○
2	F34000034	O RING	2/3	○	○	○
3	F34000030	O RING	2/3	○	○	○
4	F34000024	O RING	2/3	○	○	○
5	F46700001	AIR VALVE STEM	2/3	○	○	○
6	R46800001	AIR VALVE CORE	2/3	○	○	○
7	F15700001	AIR VALVE CAP COMP	1/2	○	○	○



FRONT FORK SFF 49 mm

CRF 250 15-17 / KXF 450 15-18 / RMZ 450 15-17

- ROD



N	REFERENCE	NAME PART	QTY	15 CRF 250	16-17 CRF 250	15 KXF 450	16 KXF 450	17-18 KXF 450	15-17 RMZ 450
1	F12A00002	TENSION ROD COMP	1			○			○
1	F12A00003	TENSION ROD COMP	1	○					
1	F12A00004	TENSION ROD COMP	1		○				
1	F12A00005	TENSION ROD COMP	1				○		
1	F12A00006	TENSION ROD COMP	1					○	
2	F25003001	PISTON RING	1	○	○	○	○	○	○
3	FYBC00001	PISTON PACKING B	1	○		○			○
3	FYBC00002	PISTON PACKING B	1		○		○		
3	FYBC00003	PISTON PACKING B	1					○	
4	FE9100001	PISTON SEAL	1	○		○			○
4	FE9100002	PISTON SEAL	1		○		○		
4	FE9100003	PISTON SEAL	1					○	



FRONT FORK SFF 49 mm

CRF 250 15-17 / KXF 450 15-18 / RMZ 450 15-17

- ROD



N	REFERENCE	NAME PART	QTY	15	16-17	15	16	17-18	15-17
				CRF 250	CRF 250	KXF 450	KXF 450	KXF 450	RMZ 450
1	FP6800001	OIL SEAL CASE B	1	○		○			○
2	F38300001	REBOUND SEAT	1	○		○			○
2	F38300002	REBOUND SEAT	1		○		○		
2	F38300003	REBOUND SEAT	1					○	
3	F35400001	OIL SEAL CASE	1	○		○			○
3	F35400002	OIL SEAL CASE	1		○		○		
3	F35400003	OIL SEAL CASE	1					○	
4	F34500003	PACKING	1	○		○			○
5	F34500001	PACKING	1	○	○	○	○	○	○
6	F34500002	PACKING	1	○		○			○
7	F34000020	O RING	1/2	○	○	○	○		○
7	F34000035	O RING	1					○	
-	F27000001	ROD GUIDE	1	○		○			○
-	F27000002	ROD GUIDE	1		○		○		
-	F27000004	ROD GUIDE	1					○	



FRONT FORK SFF 49 mm

CRF 250 15-17 / KXF 450 15-18 / RMZ 450 15-17

- PLUG BOLT AIR



N	REFERENCE	NAME PART	QTY	15	16	17-18	15-17
				KXF 450	KXF 450	KXF 450	RMZ 450
1	FB3200001	PLUG BOLT COMP	1	○			
1	FB3200002	PLUG BOLT COMP	1				○
1	FB3200003	PLUG BOLT COMP	1		○	○	
2	F45600002	AIR VALVE CAP	1	○	○	○	○
3	F34000024	O RING	1	○	○	○	○
4	F46700001	AIR VALVE STEM	1	○	○	○	○
5	R46800001	AIR VALVE CORE	1	○	○	○	○



FRONT FORK 49 mm

CRF 250 18-23 / CRF 450 17-23 / KXF 450 19-23 / RMZ 450 18-23

- OUTERTUBE
- SLIDEPIPE
- AXLEHOLDER

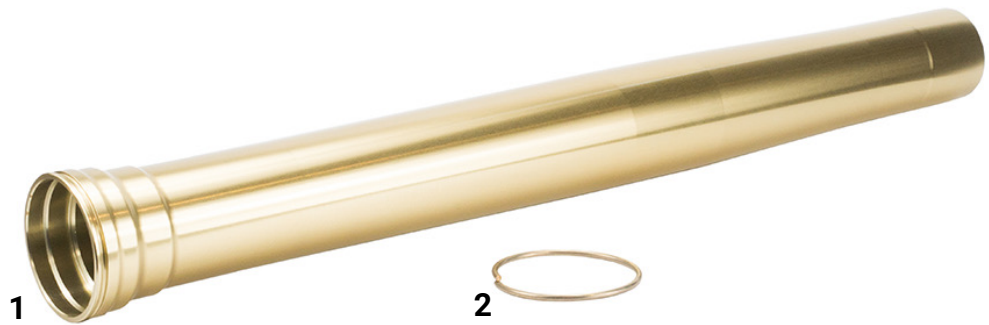

N	REFERENCE	NAME PART	QTY	18-23	17-23	19-23	18-23	19-23
				CRF 250R	CRF 450R	CRF 450WE	RMZ 450	KXF 450
1	FJ6500006	OUTER TUBE	2	○	○			
1	FJ6500008	OUTER TUBE	2				○	
1	FJ6500012	OUTER TUBE	2			○		
1	FJ6500013	OUTER TUBE	2					○
2	F36600004	STOPPER RING	2	○	○	○	○	○

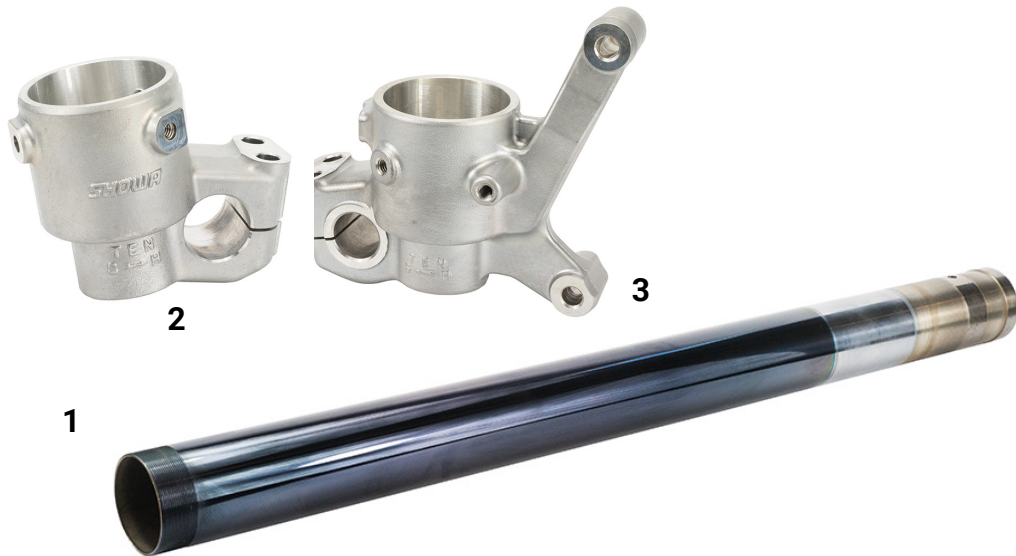

N	REFERENCE	NAME PART	QTY	18-23	17-23	19-23	18-23	19-23
				CRF 250R	CRF 450R	CRF 450WE	RMZ 450	KXF 450
1	F30504906	R SLIDE PIPE Ø49 L=595 mm CHROME	2	○	○	○	○	
1	F30504908	R SLIDE PIPE Ø49 L=595 mm DLC	2					○
1	F30504909	**OPTIONAL PART: EMERALD**	2	○	○	○	○	○
2	F44904901	R AXLE HOLDER	1	○	○	○		
2	F44904906	R AXLE HOLDER	1				○	
2	F44904907	R AXLE HOLDER KAWA	1					○
3	F44804904	L AXLE HOLDER	1	○	○	○		
3	F44804906	L AXLE HOLDER	1				○	
3	F44804907	L AXLE HOLDER KAWA	1					○



FRONT FORK 49 mm

CRF 250 18-23 / CRF 450 17-23 / KXF 450 19-23 / RMZ 450 18-23

- BUSH
- SEAL
- REBOUND SPRING



N	REFERENCE	NAME PART	QTY	18	19-23	17-18	19-23	17-18	19-23	18-23	19-23
				CRF 250R	CRF 250R	CRF 450R	CRF 450R	CRF 450X	CRF 450WE	RMZ 450	KXF 450
1	F27604901	SLIDE BUSH	2	○	○	○	○	○	○	○	○
2	F27504901	GUIDE BUSH	2	○	○	○	○	○	○	○	○
3	F35300005	SEAL SPACER	2	○		○		○			
3	F35300006	SEAL SPACER	2		○		○		○	○	○
4	F32004901	OIL SEAL	2	○	○	○	○	○	○	○	○
5	F36500003	OIL SEAL STOPPER RING	2	○	○	○	○	○	○	○	○
6	F33004903	DUST SEAL	2	○	○	○	○	○	○	○	
6	F33004901	DUST SEAL	2								○



N	REFERENCE	NAME PART	QTY	18-23	17-20	21-23	19-23	18-23	19-23
				CRF 250R	CRF 450R	CRF 450R	CRF 450WE	RMZ 450	KXF 450
1	F38500011	REB.SPG. K=71.5N/mm L=11.8mm	2	○	○		○	○	○
1	F38500013	REB.SPG. K=75.5N/mm L=15,6mm				○			



FRONT FORK 49 mm

CRF 250 18-23 / CRF 450 17-23 / KXF 450 19-23 / RMZ 450 18-23

- PISTON ROD

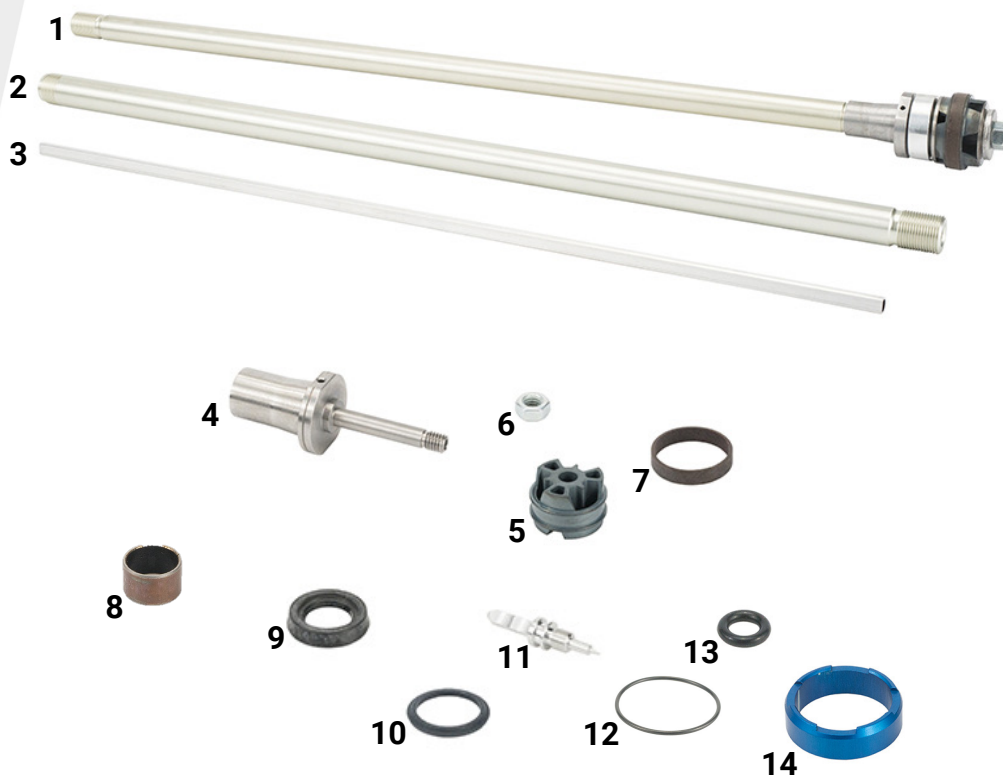

N	REFERENCE	NAME PART	QTY	18	19-21	22-23	17	18	19-20	21-23	19-20	21-23	19-23	18-23
				CRF 250R	CRF 250R	CRF 250R	CRF 450R	CRF 450R	CRF 450R	CRF 450R	CRF 450WE	CRF 450WE	KXF 450	RMZ 450
1	F12000009	PISTON ROD COMP	2				o							
1	F12000010	PISTON ROD COMP	2											
1	F12000011	PISTON ROD COMP	2	o	o									
1	F12000012	PISTON ROD COMP	2					o	o		o			
1	F12000013	PISTON ROD COMP	2											o
1	F12000015	PISTON ROD COMP	2										o	
1	F12000016	PISTON ROD COMP	2			o				o		o		
2	F30100002	ROD PIPE L=390,5 mm Ø14 mm	2	o	o		o	o	o		o		o	o
2	F30139801	ROD PIPE L=398 mm Ø14 mm	2			o				o		o		
3	F29900006	PUSH ROD	2	o	o	o	o	o	o	o	o	o	o	o
4	F27800011	ROD END	2	o	o	o	o	o	o	o	o	o	o	o
5	F24002501	PISTON	2	o	o	o	o	o	o	o	o	o	o	o
6	F55100601	NUT,HEX	2	o	o	o	o	o	o	o	o	o	o	o
7	F25002501	PISTON RING	2	o	o	o	o	o	o	o	o	o	o	o
8	F27501401	GUIDE BUSH B	2	o	o	o	o	o	o	o	o	o	o	o
9	FE9300001	ROD PACKING	2	o	o	o	o	o	o	o	o	o	o	o
10	FS0000001	BACK UP RING C	2	o	o	o	o	o	o	o	o	o	o	o
11	F51300003	ADJUST BOLT	2	o	o	o	o	o	o	o	o	o	o	o
12	F34000023	O RING	2	o	o	o	o	o	o	o	o	o	o	o
13	F34000003	O RING	2	o	o	o	o	o	o	o	o	o	o	o
14	F20900008	OIL LOCK VALVE	2	o	o	o	o	o	o	o	o	o	o	o



FRONT FORK 49 mm

CRF 250 18-23 / CRF 450 17-23 / KXF 450 19-23 / RMZ 450 18-23

- FORK BOLT



1

2

N	REFERENCE	NAME PART	QTY	18	19	20	21	22-23	17-18	19	20	21	22-23
				CRF 250R	CRF 250R	CRF 250R	CRF 250R	CRF 250R	CRF 450R	CRF 450R	CRF 450R	CRF 450R	CRF 450R
1	F45000013	FORK BOLT	2	o					o				
1	F45000016	FORK BOLT	2										
1	F45000022	FORK BOLT	2										
1	F45000023	FORK BOLT	2		o								
1	F45000024	FORK BOLT	2							o			
1	F45000025	FORK BOLT	2										
1	F45000026	FORK BOLT	2			o							
1	F45000027	FORK BOLT	2								o		
1	F45000028	FORK BOLT	2										
1	F45000029	FORK BOLT	2										
1	F45000033	FORK BOLT	2									o	
1	F45000034	FORK BOLT	2				o						
1	F45000035	FORK BOLT	2										
1	F45000036	FORK BOLT	2										
1	F45000037	FORK BOLT	2					o					
1	F45000038	FORK BOLT	2										o
2	F83900002	SHAFT	2	o	o	o	o		o	o	o		
2	F83900005	SHAFT	2					o				o	o



FRONT FORK 49 mm

CRF 250 18-23 / CRF 450 17-23 / KXF 450 19-23 / RMZ 450 18-23

- FORK BOLT



N	REFERENCE	NAME PART	QTY	19	20	21	22-23	19-23	18-23
				CRF 450WE	CRF 450WE	CRF 450WE	CRF 450WE	KXF 450	RMZ 450
1	F45000013	FORK BOLT	2						o
1	F45000016	FORK BOLT	2						
1	F45000022	FORK BOLT	2						
1	F45000023	FORK BOLT	2						
1	F45000024	FORK BOLT	2	o					
1	F45000025	FORK BOLT	2					o	
1	F45000026	FORK BOLT	2						
1	F45000027	FORK BOLT	2						
1	F45000028	FORK BOLT	2						
1	F45000029	FORK BOLT	2		o				
1	F45000033	FORK BOLT	2						
1	F45000034	FORK BOLT	2						
1	F45000035	FORK BOLT	2			o			
1	F45000036	FORK BOLT	2						
1	F45000039	FORK BOLT	2				o		
1	F45000040	FORK BOLT	2						
2	F83900002	SHAFT	2	o	o			o	o
2	F83900005	SHAFT	2			o	o		



FRONT FORK 49 mm

CRF 250 18-23 / CRF 450 17-23 / KXF 450 19-23 / RMZ 450 18-23

- FORK BOLT



N	REFERENCE	NAME PART	QTY	18	19	20-21	22-23	17-18	19	20	21-23	19	20	19-23	18-23
				CRF 250R	CRF 250R	CRF 250R	CRF 250R	CRF 450R	CRF 450R	CRF 450R	CRF 450R	CRF 450R	CRF 450W	CRF 450W	KXF 450
1	F38100018	SPG B K=22.6N/mm L=100mm	2		o		o	o			o				o
1	F38100019	SPG B K=21.5N/mm L=100mm	2	o		o								o	
1	F38100020	SPG B K=24,2N/mm L=100mm	2							o			o		
1	F38100021	SPG B K=23.0N/mm	2						o			o			
1	F39000003	SPG B	2												
2	F27A00008	ROD END B	2					o						o	
2	F27A00011	ROD END B	2	o	o										o
2	F27A00016	ROD END B	2			o	o		o	o	o	o	o		
3	F55101201	NUT,HEX	2	o	o	o	o	o	o	o	o	o	o	o	o
4	FL4000005	PISTON	2	o	o	o	o	o	o	o	o	o	o	o	o
5	F34000026	O RING	2	o	o	o	o	o	o	o	o	o	o	o	o
6	F34000029	O RING	2	o	o	o	o	o	o	o	o	o	o	o	o
7	F45300006	PLUG BOLT	2	o	o	o									
7	F45300001	PLUG BOLT	2				o	o	o	o	o	o	o	o	o
8	F34000017	O RING (NEEDLE)	2	o	o	o	o	o	o	o	o	o	o	o	o
8	F34000013	O RING	2	o	o	o	o	o	o	o	o	o	o	o	o
9	F51000001	SHAFT NUT	2	o	o	o	o	o	o	o	o	o	o	o	o
10	F20600001	BALL	2	o	o	o	o	o	o	o	o	o	o	o	o



FRONT FORK 49 mm

CRF 250 18-23 / CRF 450 17-23 / KXF 450 19-23 / RMZ 450 18-23

- FREE PISTON



REFERENCE	NAME PART	QTY	18-21 CRF 250R	17-18 CRF 450R	19-20 CRF 450R	17-20 CRF 450X	19-20 CRF 450WE	19-22 KXF 450	18-22 RMZ 450
1	F86000007	FREE PISTON COMP	○	○		○			
1	F86000008	FREE PISTON COMP			○		○	○	○
3	FK4500001	PACKING B	○	○	○	○	○	○	○
4	F34000053	O RING							
4	F34000025	O RING	○	○	○	○	○	○	○
3	F32200001	GAS SEAL							
5	F25200001	PISTON RING B	○	○	○	○	○	○	○
6	FK7400001	SLID BUSH C	○	○	○	○	○	○	○



N	REFERENCE	NAME PART	QTY	18-22 CRF 250R	17-22 CRF 450R	17-22 CRF 450X	19-22 CRF 450WE	19-22 KXF 450	18-22 RMZ 450
1	F34000028	O RING	1	○	○	○	○	○	○
2	F41000002	LOCK NUT	2	○	○	○	○	○	○
3	FB2600006	CENTER BOLT COMP	1	○	○	○	○	○	○



FRONT FORK 49 mm

CRF 250 18-23 / CRF 450 17-23 / KXF 450 19-23 / RMZ 450 18-23

- FREE PISTON

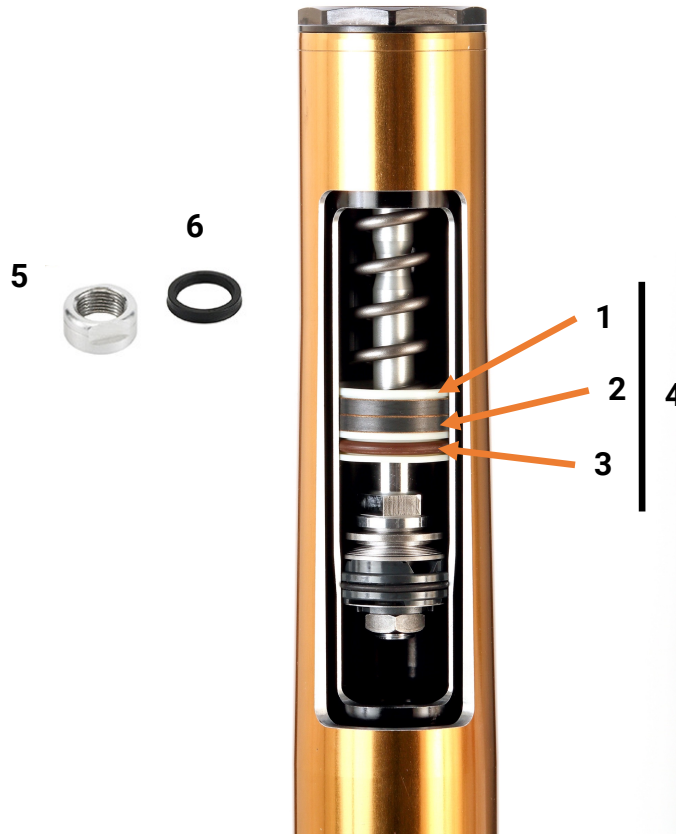

	REFERENCE	NAME PART	QTY	22-23 CRF 250R	21-23 CRF 450R	21-22 CRF 450WE
1	F29700003	FREE PISTON SINGLE	2	○	○	○
2	FK7400001	SLID BUSH C	2	○	○	○
3	F34000053	O RING	2	○	○	○
4	F86000011	FREE PISTON COMP	2	○	○	○
5	F51000001	SHAFT NUT	2	○	○	○
6	F32200001	GAS SEAL	2	○	○	○
-	F35300008	SEAL SPACER	2	○	○	○
-	F36600005	STOPPER RING	4	○	○	○



FRONT FORK 49 mm

CRF 250 18-23 / CRF 450 17-23 / KXF 450 19-23 / RMZ 450 18-23

- SPRING



N	REFERENCE	NAME PART	QTY	18 CRF 250R	19-23 CRF 250R	17 CRF 450R	18-23 CRF 450R	19-23 CRF 450WE	19-23 KXF 450	18-23 RMZ 450
1	F38004605	SPRING K=4.6N/mm L=472mm	2	○						
1	F38004804	SPRING K=4.8N/mm L=472mm	2		○	○				
1	F38005002	SPRING K=5.0N/mm L=472mm	2				○	○	○	○



SEAL & BUSH APPLICATION LIST FRONT FORK



N	REFERENCE	NAME PART	QTY	Ø47	Ø47	Ø48	Ø48	Ø49	Ø47	Ø49	Ø49	Ø47	Ø48	Ø49	Ø47	Ø47	Ø47	Ø48	Ø47	Ø48	Ø49
				97-07 CR 250	04-09 CRF 250	10 CRF 250	11-14 CRF 250	15-21 CRF 250	02-08 CRF 450R	17-23 CRF 450R	17-23 CRF 450X	06-12 KXF 250	13-19 KXF 250	15-23 KXF 450	01-08 RM 125	04-09 RM 250	07-12 RMZ 250	13-15 RMZ 250	04-12 RMZ 450	13-14 RMZ 450	15-23 RMZ 450
1	F32004701	OIL SEAL	2	o	o							o			o	o	o		o		
1	F32004801	OIL SEAL	2			o	o														
1	F32004802	OIL SEAL	2										o						o		o
1	F32004901	OIL SEAL	2					o	o	o	o			o							o
2	F33004701	DUST SEAL	2	o	o							o			o	o	o		o		
2	F33004801	DUST SEAL	2			o	o														
2	F33004802	DUST SEAL	2										o						o		o
2	F33004901	DUST SEAL	2											o							
2	F33004902	DUST SEAL	2																		o
2	F33004903	DUST SEAL	2					o	o	o	o										
3	F36500001	OIL SEAL STOPPER RING	2			o	o						o						o		o
3	F36500002	OIL SEAL STOPPER RING	2	o	o							o	o		o	o	o		o		
3	F36500003	OIL SEAL STOPPER RING	2					o	o	o	o			o							o
4	F27604702	SLIDE BUSH	2	o	o								o			o	o	o		o	
4	F27604801	SLIDE BUSH	2			o	o						o						o		o
4	F27604901	SLIDE BUSH	2					o	o	o	o			o							o
5	F27504702	GUIDE BUSH	2	o	o								o			o	o	o		o	
5	F27504801	GUIDE BUSH	2			o	o						o						o		o
5	F27504901	GUIDE BUSH	2					o	o	o	o			o							o
6	F35300001	SEAL SPACER	2			o															
6	F35300002	SEAL SPACER	2				o						o						o		o
6	F35300004	SEAL SPASER	2	o	o																
6	F35300003	SEAL SPASER	2									o			o	o	o		o		
6	F35300005	SEAL SPACER	2					o	o	o	o										
6	F35300006	SEAL SPACER	2												o						o

SHOWA

by GENUINE PARTS EUROPE

REAR SHOCK PARTS



REAR SHOCK

CRF / KXF / RMZ

- PISTON



N	REFERENCE	NAME PART	QTY	HONDA			KAWASAKI		SUZUKI								
				09-23 CRF 250	17-23 CRF 450	19-23 CRF 450W E	09-19 KXF 250	15-23 KXF 450	09 RMZ 250	10 RMZ 250	11-12 RMZ 250	13-15 RMZ 250	09 RMZ 450	10 RMZ 450	11-12 RMZ 450	13-17 RMZ 450	18-23 RMZ 450
1	R55101601	NUT,HEX	1														
1	R55101401	NUT,HEX	1														
1	R55101201	NUT,HEX	1														
2	R25005001	PISTON RING	1														
2	R25005004	PISTON RING	1														
3	R24005001	PISTON	1														
3	R24005002	PISTON	1														
3	R24005003	PISTON	1														
3	R24005004	PISTON	1														
3	R24005006	PISTON	1														
4	R34505001	PACKING	1														
5	R35205001	BUCK UP RING	2														
6	R25005002	PISTON RING	1														
6	R25005002	PISTON RING	2														
7	R34005001	O RING	2														
7	R34000008	O RING	2														

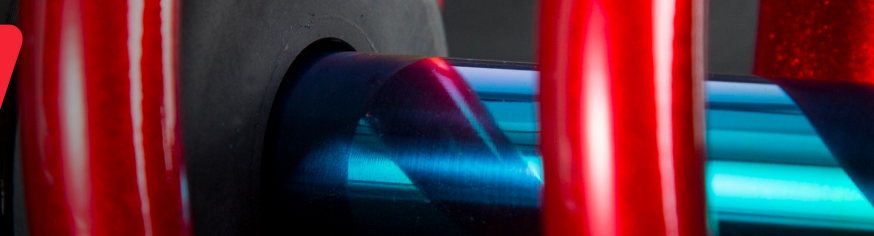

REAR SHOCK

CRF / KXF / RMZ

- SEAL HEAD
- STOPPER RUBBER



N	REFERENCE	NAME PART	QTY	HONDA				KAWASAKI				SUZUKI		
				09 CRF 250	10-23 CRF 250	17-23 CRF 450	19-23 CRF 450W E	09 KXF 250	10-19 KXF 250	15 KXF 450	16-23 KXF 450	09-15 RMZ 250	09-17 RMZ 450	18-23 RMZ 450
1	R26901601	OIL SEAL GUIDE	1	○	○	○	○	○	○	○	○			○
1	R26901801	OIL SEAL GUIDE	1									○	○	
2	R33001601	DUST SEAL	1	○	○	○	○	○	○	○	○			○
2	R33001801	DUST SEAL	1									○	○	
3	R32001601	OIL SEAL	1	○	○	○	○	○	○	○	○			○
3	R32001801	OIL SEAL	1									○	○	
4	R35201801	BUCK UP RING	1									○	○	
5	R27501601	GUIDE BUSH	1	○	○	○	○	○	○	○	○			○
5	R27501801	GUIDE BUSH	1									○	○	
6	R38800001	REBOUND RUBBER	1	○										
6	R38800002	REBOUND RUBBER	1		○	○	○	○	○	○	○	○	○	
6	R38804001	REBOUND RUBBER	1											○
7	R34005002	O RING	1	○	○	○	○	○	○	○	○	○	○	○
8	R36600001	STOPPER RING	1	○	○	○	○	○	○	○	○	○	○	○
9	R38502301	REBOUND SPG L=23mm	1	○										
9	R38502302	REBOUND SPG L=23mm	1		○	○	○	○				○	○	
9	R38502701	REBOUND SPG L=27mm	1						○	○	○			
10	R27301602	ROD GUIDE CASE	1	○	○	○	○							
10	R27301601	ROD GUIDE CASE	1					○	○	○	○			
10	R27301801	ROD GUIDE CASE	1									○	○	
10	R27301603	ROD GUIDE CASE	1											○
11	R41501601	STOPPER RUBBER	1	○	○	○	○	○	○		○			○
11	R41501602	STOPPER RUBBER	1							○				
11	R41501801	STOPPER RUBBER	1									○	○	

REAR SHOCK

CRF / KXF / RMZ

- BLADDER
- CHAMBER CAP



N	REFERENCE	NAME PART	QTY	HONDA					KAWASAKI				SUZUKI				
				09 CRF 250	10-17 CRF 250	18-23 CRF 250	17-23 CRF 450	19-23 CRF 450W E	09 KXF 250	10-19 KXF 250	15-18 KXF 450	19-23 KXF 450	09 RMZ 250	10-15 RMZ 250	09 RMZ 450	10-17 RMZ 450	18-23 RMZ 450
1	R29606001	BLADDER	1		o												
1	R29610502	BLADDER	1	o					o	o	o			o		o	
1	R29610301	BLADDER	1										o		o		
1	R29609601	BLADDER	1			o	o	o									
1	R29600003	BLADDER	1									o				o	
2	R45500001	AIR VALVE	1	o	o	o	o	o	o	o	o	o	o	o	o	o	
3	R46800001	AIR VALVE CORE	1	o	o	o	o	o	o				o	o	o	o	
4	R15700001	AIR VALVE CAP COMP	1	o	o	o	o	o	o				o	o	o	o	
6	R36600003	STOPPER RING	1		o												
6	R36600004	STOPPER RING	1	o		o	o	o	o				o	o	o	o	
6	R36600008	STOPPER RING	1							o	o						
6	R36600009	STOPPER RING	1									o				o	
5	RB0600001	CHAMBER CAP COMP	1		o												
5	R60700001	CHAMBER CAP COMP	1	o		o	o	o	o								
5	R60700002	CHAMBER CAP COMP	1													o	
5	RB0600002	CHAMBER CAP COMP	1							o	o						
5	RB0600003	CHAMBER CAP COMP	1											o		o	
5	RB0600004	CHAMBER CAP COMP	1												o		
5	RB0600005	CHAMBER CAP COMP	1										o				
5	RB0600006	CHAMBER CAP COMP	1									o					

REAR SHOCK

CRF / KXF / RMZ

- SPRING ADJ.



N	REFERENCE	NAME PART	QTY	HONDA					KAWASAKI			SUZUKI				
				09 CRF 250	10-12 CRF 250	13-23 CRF 250	17-23 CRF 450	19-23 CRF 450WE	09-19 KXF 250	15-18 KXF 450	19-23 KXF 450	09-12 RMZ 250	13-15 RMZ 250	09-12 RMZ 450	13-17 RMZ 450	18-23 RMZ 450
1	RF6300001	SPG ADJ NUT	1	○								○		○		
2	R39100001	SPG ADJ	1	○								○		○		
1	RF6300002	SPG ADJ NUT	1			○	○	○	○	○			○		○	
2	R39100002	SPG ADJ	1			○	○	○	○	○			○		○	
1	RF6300003	SPG ADJ NUT	1		○											
2	R39100003	SPG ADJ	1		○											
3	R39300001	SPG SEAT B	1	○	○	○	○	○	○	○	○	○	○	○	○	○
2	R39100006	SPG ADJ	1								○					○
3	R39200002	SPG SEAT	1								○					○
4	R36800001	STOPPER RING C	1	○	○	○	○	○	○	○	○	○	○	○	○	○
	R53100001	BAND														○

REAR SHOCK

CRF / KXF / RMZ

- SPRING



1

REFERENCE	NAME PART	QTY	HONDA					KAWASAKI						SUZUKI												
			09-13 CRF 250	14 CRF 250	15-23 CRF 250	17 CRF 450	18-23 CRF 450	19-23 CRF 450W E	09-11 KXF 250	12-16 KXF 250	17-19 KXF 250	15 KXF 450	16 KXF 450	17-18 KXF 450	19-23 KXF 450	09 RMZ 250	10 RMZ 250	11-12 RMZ 250	13-15 RMZ 250	09 RMZ 450	10 RMZ 450	11-12 RMZ 450	13-16 RMZ 450	17 RMZ 450	18-23 RMZ 450	
R38005305	SPRING 53N/mm	1													o											
R38005501	SPRING 54N/mm	1																								
R38005601	SPRING 55N/mm	1																		o						
R38005701	SPRING 56/Nmm	1														o	o									
R38005801	SPRING 57N/mm	1																			o	o				
R38005502	SPRING 54N/mm	1																o								
R38005702	SPRING 56N/mm	1																					o			
R38005302	SPRING 52N/mm	1	o																							
R38005303	SPRING 52N/mm	1		o																						
R38005304	SPRING 52N/mm	1			o																					
R38005403	SPRING 54N/mm	1				o																				
R38005603	SPRING 56N/mm	1					o	o																		
R38005202	SPRING 51 N/mm	1							o				o													
R38005401	SPRING 53N/mm	1								o		o														
R38005203	SPRING 52 N/mm	1									o			o												
R38005602	SPRING 56N/mm	1																						o		o
R38005402	SPRING 54N/mm	1													o											o



FRONT FORK OIL		
	REFERENCE	FORMAT
A15-00 15,3 cSt @ 40°C	L598A15001	FF oil A15-00 1L
	L598A15020	FF oil A15-00 CAN 20L
	L598A15005	FF oil A15-00 5 L
	L598A15200	FF oil A15-00 drum 200L
SS05 15,1 cSt @ 40°C	L598005001	FF oil SS05 1L
	L598005020	FF oil SS05 CAN 20L
	L598005005	FF oil SS05 5L
	L598005200	FF oil SS05 drum 200L

REAR SHOCK OIL		
	REFERENCE	FORMAT
SS25 3,63 cSt @ 40°C	L598025001	RC oil SS25 1L
	L598025020	RC oil SS25 CAN 20L
	L598025024	RC oil SS25 5 L
	L598025200	RC oil SS25 drum 200L

SHOWA

by GENUINE PARTS EUROPE

OILS & GREASE



TECHNICAL GREASE	
REFERENCE	FORMAT
G597000500	500 gr.

SHOWA

by **GENUINE PARTS EUROPE**

MORE INFO:

contact@showabygenuinepartseurope.com

CATALOG VERSION:V.23.1